



EMIRA

OWNER'S HANDBOOK

Welcome to the Lotus Family

Lotus is a driving icon that throughout decades of development has remained true to its founding principles of innovation, purity and competitiveness.

Your new Lotus is built in the true tradition of Lotus sports cars; high performance with precision handling. This is a serious driver's car that consistently delivers dynamic and uncompromising performance, just as you would expect from a road car developed on the racetrack.

Its lightweight construction, outstanding agility and aerodynamic styling firmly sets it apart from its rivals. Nothing is superfluous, it's designed to perform with no compromise, reflecting the true legendary Lotus racing heritage and ensuring that you, the driver is at one with your car.

TABLE OF CONTENTS

INTRODUCTION

Welcome to the Lotus Family	3
-----------------------------------	---

HANDBOOK INFORMATION

Lotus Cars Website	11
Owner's Handbooks	11
Customer Assistance	11
Printed Handbooks	11
Using This Handbook	12
Warnings and Notices	12
Safety Information	14
Copyright Information	15
Crash Event Data	15
Engine Data Recording	15
Software Updates	15
Vehicle Identification	16
Central Display	16
Windscreen	16
Chassis	16
Fuel Tank Bay	16

VEHICLE OVERVIEW

Exterior	18
Cabin Driving Area	20
Overhead Console	22
Steering Wheel Switches	23
Centre Console Controls	24
Door Panel Control Switches	25

SAFETY

Seatbelts	27
-----------------	----

Inertia Reel Seat Belts	27
Seat Belt Pretensioners	27
Wearing a Seat Belt	27
Fitting During Pregnancy	28
Door/Seat Belt Reminder	29
Overhead Console	30
Child Safety	30
Child Restraints	30
Suitable Child Seats	30
Child Seat Installation	31
Rearward Facing Child Seat	31
Suitable Child Seats	32
Airbag Safety System	33
Airbag Warning Lamp	33
Seat Belt Pretensioners	33
Driver and Passenger Airbags	34
Passenger Airbag Switch	35
Deactivating Passenger Airbag	35
Side Airbags	36
Side Airbags and Child Seats	37
Inflatable Curtains	37
Safety Mode	38

KEYS, LOCKS & ALARM

Keys	40
Keyfob Storage	40
Ordering Additional Keyfobs	40
Lost or Stolen Keyfobs	40
Keyfob Reminder	40
Keyfob Buttons	41
Unlocking Options	41
Keyfob Range	41

External Locking/Unlocking Confirmation .	41
Lock and Alarm Indicator	42
Lock Indication Settings	42
Locking	42
Unlocking	43
Opening a Door from the Outside	43
Automatic Relocking	43
Automatic Locking	43
Keyfob Does Not Work	43
Unlocking in an Accident	43
Interior Door Locking/Unlocking	44
Door Switches	44
Drive-Away Locking	44
Unlocking - Door Release Handle	44
Tailgate Opening Using Keyfob	45
Tailgate Opening Using Switch	45
Lifting the Tailgate	46
Closing the Tailgate	46
Luggage Weight	46
Emergency Release Handles	47
Inside Cabin	47
Inside Luggage Compartment	47
Keyfob Removed from Vehicle	47
Keyfob Battery	48
Emergency Key Blade	50
Refitting the Key Blade	50
Deactivating the Vehicle Alarm	51
Alarm	52
Alarm Triggering Signals	52
Immobiliser	52
Lock and Alarm Indicator	52

TABLE OF CONTENTS

Movement and Tilt Sensors	53
Alarm System Fault	53
Arming the Alarm	53
Disarming the Alarm	53
Lotus Vehicle Tracker	54
Switching off a Triggered Alarm	54
Automatic Re-arming	54
Reduced Alarm Level	54
Alarm/Locking Preset Options.....	55

DISPLAYS, WARNINGS AND GAUGES

Driver Display	57
Tour and Sport Mode Displays.....	57
Tour Mode	57
Sport Mode.....	57
Track Mode.....	58
Indicator Symbols	58
Indicator Check	58
Warning Symbol Illumination	58
System Status Indicator Symbols.....	59
Warning Symbol Illumination	60
Messages.....	61
Fuel Gauge.....	62
Engine Coolant Temperature Gauge	63
Clock.....	63
Outside Air Temperature	64
Speedometer.....	64
Tachometer	64
Cold Engine Speed	65
Performance Gear Shift Lighting.....	65
Gear Display	67
Gear Shift Indicator	67

Drive Mode Display.....	67
Lotus Launch Control.....	68
Lotus Launch Control Preparation	68

DRIVER DISPLAY WIDGETS

Widget Options.....	71
Trip Computer	72
Odometer Screen.....	72
Odometer	72
Trip A.....	72
Trip B	72
Trip A & B Screens.....	72
Performance	73
g-Force Meter	73
Performance Gauges	73
Downforce Gauge.....	73
Track Widget	73
Manual Lap Timer	74
Vehicle Health.....	77
Tyre Pressures.....	77
Service Due Status	77
Notifications.....	77
Media	78
Radio.....	78
Bluetooth	78
Apple CarPlay.....	78
Android Auto.....	78
USB	78
Phone	79
Access Recent Calls	79
Access Favourite Contacts.....	79
Voice Call (If Available).....	79

DRIVER ASSISTANCE

Cruise Control.....	81
Increasing Cruising Speed	82
Decreasing Cruising Speed	82
Manual Deactivation.....	82
Increasing Vehicle Speed	82
Resuming Cruise Control.....	82
Speed Limiter	83
Speed Limiter Limitations.....	85
Park Assist System	86
Washing Park Assist System Sensors.....	87
Park Assist System Presets	87
Parking Assist Camera	88
Parking Assist and Camera Options	88

CENTRE DISPLAY SCREEN

Centre Display Overview	91
Display Operation	92
Display Navigation	92
Automatic Activation/Deactivation.....	93
Manual Deactivation.....	93
Illumination	93
Device Projection	93
Notification Centre.....	94
Global Settings and App Options.....	95
Quick Panel	97
App Launcher	98
System Settings	99
Language Settings.....	100
Keyboard.....	100
Widgets.....	103
Driver Profiles.....	104

TABLE OF CONTENTS

Adding a New Profile.....	105
Removing a Profile	106
Wrong Pin Code	106
Editing a Profile.....	106
Voice Assistant (If Available)	107
Cancelling Voice Assistant	108

LIGHTING

Exterior Lighting.....	111
Light Switch	111
Daytime Running Lights	111
Position Lights.....	111
Low Beam Lights.....	111
AUTO	111
High/Low Beam Headlights.....	112
Rear Fog Light	112
Direction Indicators	112
Trip A Reset	113
Hazard Warning Lights	113
Brake Lights	114
Emergency Brake Lights	114
Reverse Light.....	114
Approach Lighting	114
Home Safety Lights	115
Light Failure	115
Exterior Lighting Presets.....	115
Interior Lighting.....	116
Overhead Console Switches.....	116
Interior Lights.....	116
Glovebox Lighting.....	116
Vanity Mirror Lighting.....	116
Luggage Compartment Lighting	116

Ambient Lighting.....	116
Courtesy Lighting.....	116
Ground Lighting.....	117
Brightness Adjustment.....	117

WINDSCREEN, WINDOWS, MIRRORS AND SUN VISORS

Wipers/Washers	119
Wipers	119
Intermittent Wiping	119
Continuous Wiping.....	119
Rain Sensor Wiping.....	120
Automatic Car Washes	120
Deactivating Rain Sensor Wiping.....	120
Windscreen Washers.....	121
Washer Fluid Level.....	121
Power Door Windows.....	121
Automatic Drop/Raise.....	122
Pinch Protection	122
Resetting Automatic Drop/Raise/Pinch Protection	122
Door Mirrors.....	122
Adjusting the Door Mirror Glasses	123
Interior Rearview Mirror.....	124
Manual Dimming.....	124
Automatic Dimming Mirror	125
Sun Visors	125

CABIN STORAGE AND POWER SOCKETS

Glovebox	127
Centre Console.....	127
Door Pockets	128

Luggage Nets	128
Rear Cabin Net.....	128
Centre Console Net	128
Power Sockets.....	129
12 Volt Power Socket.....	129
USB Ports.....	129

SEATS AND STEERING WHEEL

Seats	132
Power Seats	132
Seat/Door Mirror Memory Switches.....	133
Seat Fold.....	134
Horn	134
Steering Wheel Adjustment.....	134
Electronic Steering Column Lock	135

CLIMATE CONTROL

Climate Control System	137
Climate Control Switches	137
Air Conditioning	137
Air Temperature.....	138
Air Distribution.....	138
Demister.....	139
Heated Rear Screen/Door Mirrors	139
Air Recirculation	140
Auto Climate	140
Automatic Climate Temperature.....	141
Climate Fan.....	141
Air Vents	141
Adjusting Air Vents	142
Pollen Filter	142
Pollen Filter Replacement	142

TABLE OF CONTENTS

Interior Air Cleaning System	142
Active Electrical Module Cooling	142
Centre Display	143
Presets Bar	143
Navigation Bar	144
Fan Speed	145
Heated Seat Temperature	145
Maximum A/C	145
Voice Assistant (If Available)	147

STARTING AND DRIVING

Ignition Modes	149
Electronic Steering Column Lock	149
Starting the Engine	150
Emergency Starting	150
Switching off the Engine	151
Manual Transmission	151
Selecting Reverse Gear	152
Clutch Pedal	152
Automatic Transmission	152
System Modes	152
Gear Selector	153
Selecting Gear	153
P – Park	154
Automatic Park Activation	154
R - Reverse	154
N – Neutral	155
D – Drive	155
Unsuitable PRND Selection	155
Drive Selection in Manual Mode	155
Kick-Down	155
Transmission Warning Messages	155

Manual Selection Mode	156
Activating Permanent Manual Mode	156
Using the Gear Selector	156
Activating Temporary Manual Mode	157
Unsuitable Gear Selection	157
Temporary to Permanent Mode	158
Deactivating Manual Selection	158
Sport & Track Modes	158
Braking System	159
Footbrake	159
Brake Pedal	159
Brake Pads	159
Anti-Lock Braking System	160
Hydraulic Brake Assist	160
Traction Control System	161
Electronic Stability Control	161
Sport Mode	161
Electric Parking Brake	162
Emergency braking	162
Parking Brake Activation	162
Automatic Activation	163
Parking Brake Deactivation	163
Automatic Deactivation	163
Hill Start Assist	164
Drive Modes	164
Tour Mode	164
Sport Mode	164
Track Mode (If Equipped)	164
ESC 'Off'	165
Default Drive Mode Setting	165
Changing Drive Mode	165

RUNNING-IN

Engine	169
Brakes	169
Tyres	169
Stopping the Engine	169

FUEL FILLING AND FUEL

Fuel Filler Flap	171
Fuel Filling	171
Using a Filling Station	171
Using a Fuel Can	172
Fuel Requirement	172

HOMELINK®

Programming	174
Reprogramming Individual Buttons	175
Resetting the Buttons	175

LOTUS E-CALL

Manual SOS Call	177
Automatic SOS Call	177
Coverage	177
Self-Test and Fault Warnings	177

VEHICLE CARE

Accessories and Modifications	180
Vehicle Storage	180
After Storage	180
Car Covers	181
Owner Maintenance	182
Track Use	182

TABLE OF CONTENTS

General Safety.....	182	TPMS Sensor Renewal Intervals	202	Under Vehicle Cleaning.....	226
Service Reminder.....	183	Calibrating Tyre Pressure Monitoring		Tar Spots.....	226
Resetting the Service Reminder	183	Sensor	202	Windscreen Cleaning.....	226
Daily Checks.....	184	Wheel Changing.....	203	Alloy Road Wheels.....	226
Regular Checks.....	184	Wheel Removal	203	Exterior Lighting.....	227
Front Access Panel	185	Wheel Fitment	204	Park Assist System Sensors	227
Unlocking/Opening.....	185	Raising the Vehicle.....	205	Park Assist Camera Lens.....	227
Closing/Locking.....	185	Battery.....	206	Paintwork Polishing.....	227
Engine Compartment	186	Battery Access	206	Interior Cleaning.....	227
Engine Oil Level Check	188	Battery Replacement	206	Centre Display	227
Windscreen Washer Reservoir	189	Battery Disposal	206	Cloth Trim.....	228
Topping Up.....	189	Battery Charging.....	207	Leather & Vinyl Trim.....	228
Wiper Blade Renewal	190	Jump Starting	207	Alcantara® Trim.....	228
Engine Coolant.....	191	Fuses.....	209	Seat Belt Cleaning	228
Topping up	191	Fusebox Locations	209	Footwell Cleaning.....	229
Charge Cooler Expansion Tank	192	Fuse Replacement	209	Sill Trims	229
Steering Fluid Reservoir	192	Front Fusebox.....	210	Door Lock.....	229
Brake/Clutch Fluid Level Check.....	193	Footwell Fusebox.....	214	Severe Service Conditions	230
Topping Up	193	Rear Fusebox	218	Recommended Lubricants.....	230
Tyre Inspection	195	Battery Fusebox	222		
Wear Indicators	195	Exterior Lamps.....	223	TECHNICAL DATA	
Recommended Tyre Pressures.....	195	Front Lamps	223	Recommended Fluids and Lubricants ..	232
Cold Tyres	195	Rear Lamps	223	Capacities	233
Tyre Pressures For Track Use	195	Vehicle Recovery	223	WLTP Figures.....	233
Michelin Pilot Sport Cup 2 Tyres	196	Using the Recovery Eye	224	Fuel Consumption.....	233
Adjusting Tyre Pressures.....	196	Transporter Recovery	224	CO ₂ Emissions	233
Tyre Replacement.....	197	Vehicle Tie-Down.....	225	Unleaded Fuel Requirement.....	233
Winter Tyres	197	Vehicle Towing.....	225	Engine Data.....	233
Snow Chains.....	197	Towing Automatic Models	225	Dimensions.....	234
Tyre Inflator Kit.....	197	Towing a Trailer.....	225	Weights	234
Tyre Pressure Monitoring System.....	201	Exterior Cleaning	225	Tyres	235
System Malfunction.....	202	Handwashing	226	Snow Chains.....	235

TABLE OF CONTENTS

Battery 236

DECLARATIONS OF CONFORMITY237

INDEX 239

HANDBOOK INFORMATION

Handbook Information

The owner's handbook is available in digital and printed formats. It can be viewed from the Emira mobile app and on the Lotus Cars website. A quick start guide has been supplied with the vehicle. A full printed version of owner's manual can be ordered from any Lotus Retailer.

Lotus Cars Website

Further information and support for your vehicle is available on the Group Lotus website.

Go to [lotuscars.com](https://www.lotuscars.com) to visit the page. Support is available for most markets.

Owner's Handbooks

These are available in PDF format. Select vehicle model and model year to download the manual as required.

Customer Assistance

The Group Lotus website has contact details for customer support as well as the Lotus Retailer network.

Printed Handbooks

A quick guide has been supplied with the vehicle in printed format with information on the most commonly used functions in the vehicle which should be used in conjunction with either the electronic or hard copy versions of the main owner's handbook.

HANDBOOK INFORMATION

Using This Handbook

This handbook should be read before driving the vehicle for the first time.

The content includes important safety information to protect you from injury, explanations and instructions for operating the driving controls, owner maintenance requirements, technical specifications and an explanation of the warranty. It is not intended to provide all the technical information required for servicing and should any adjustment become necessary, owners are urged to contact their Lotus Retailer. It is a requirement of the warranty and the responsibility of the owner/driver, to ensure that servicing of the vehicle is carried out at the correct intervals.

A comprehensive content list (see page 4) and an alphabetical index at the back of this book are provided to help you find information about any particular feature or topic.

The information and specifications included in this publication were correct at the time of printing. Lotus has a policy of continuous

product improvement and reserves the right to discontinue or change specification, design or equipment at any time without notice and without incurring any obligation whatsoever. You should keep in regular contact with your Lotus Retailer to ensure that you are kept informed of any technical developments which may improve the specification, performance or safety of your vehicle.

This handbook covers various models and may include descriptions of equipment and features which are not fitted on your particular vehicle.

Warnings and Notices

Included in Handbook



WARNING: Used with the safety alert symbol, indicates a risk of death or serious injury for the driver, other vehicle occupants, other road users or bystanders.



CAUTION: Messages are intended to help you avoid damage to your vehicle, other property or the environment.



NOTE: Messages are intended to assist or guide the reader to other sources of information.

⚠ WARNING: Messages indicating the presence of danger and if ignored, may result in serious personal injury or fatality

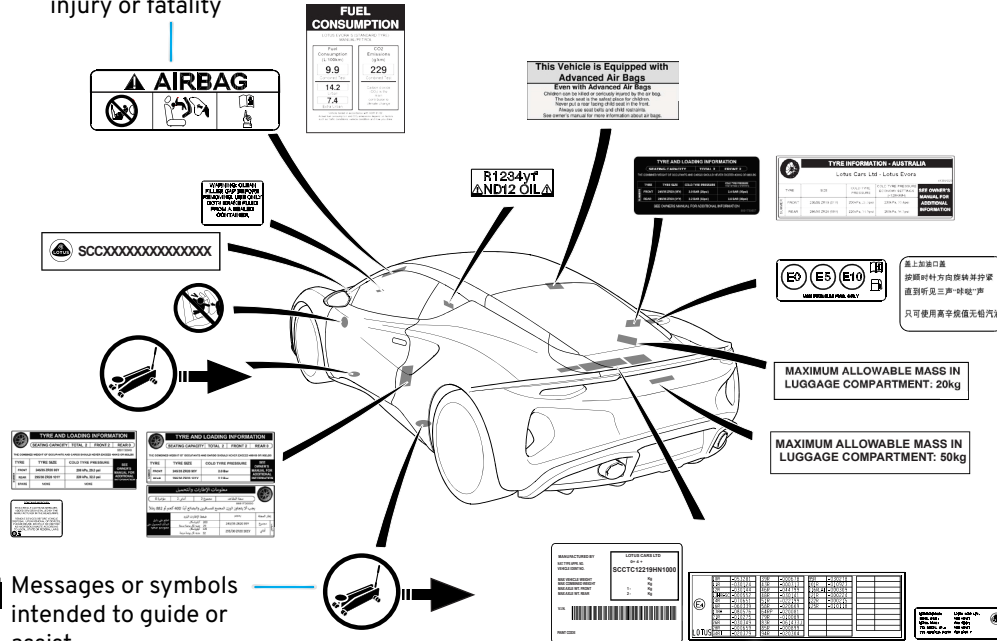

📖 Messages or symbols intended to guide or assist

i Labels displaying specific vehicle information

On Vehicle

Where necessary, decals can be found on the vehicle showing warnings and information. Labels and messages may differ between model type and market.

HANDBOOK INFORMATION

Safety Information



WARNING: The following paragraphs of this section contain safety messages.

- All occupants must wear seat belts.
- Never drive whilst under the influence of alcohol or drugs.
- Never drive when tired.
- Never use a hand-held mobile phone, map read or attempt other distracting activities whilst driving.
- Avoid adjusting the infotainment settings whilst driving.
- Always obey all traffic laws and regulations, never exceed the local speed limit and consider the traffic and road conditions.
- Be particularly careful driving on slippery or wet surfaces.
- Restrain from using full vehicle performance until experience has been gained and only in circumstances when it is legal and safe to do so.

- Adhere to the Maintenance Schedule and keep the vehicle in good condition.
- Never leave young children unattended in the vehicle.
- Read and take account of all safety messages in this handbook.
- For accessories and modifications, see page 180.



WARNING: Do not become distracted by the centre screen display whilst driving. You could cause an accident.

It is recommended to stop the vehicle before using certain options available, such as using the keyboard, entering address and contact information etc.

Before Driving Your Vehicle

Before each journey:

- Check tyres for damage, wear and correct pressure. Incorrect inflation pressure degrades vehicle handling (See 'Tyres' on page 194).
- Check all windows, mirrors, camera lenses and lights are clear and unobstructed and all lights are correctly working.
- Check that the front body access panel fixings are secure.
- Adjust the seat and mirrors and familiarise yourself with the controls.
- Check all instruments and tell tale lamps are reading correctly.
- Ensure that all occupants are properly restrained by their seat belts.

Copyright Information

The Bluetooth word mark and logos are registered trademarks owned by the Bluetooth SIG, Inc. and any use of such marks by Lotus Cars is under licence.

Apple CarPlay, iPhone and iPod are trademarks of Apple Inc.

Android™ and Android Auto™ are trademarks of Google LLC.

Other trademarks and trade names are those of their respective owners.

Handbook Images

Some instrument panel and central display menu option screen images contained in this handbook have been reformatted to make them suitable for publication.

Crash Event Data

Your vehicle is equipped with an event data recorder. The main purpose is to record information related to vehicle crashes or accidents. The data recorded may provide a better understanding of the circumstances in which crashes and injuries occur.

Some of the information recorded is required to diagnose and rectify vehicle faults during servicing and maintenance so that Lotus can satisfy legal requirements and other regulations.

The information is also used for research reasons by Lotus to continuously develop quality and safety.

The event data recorder cannot identify who is driving the vehicle or the location of any incidents. Because of legislation and regulations, Lotus may be required to disclose other types of recorded data to certain government agencies who may assert a legal right to have access to it, such as, but not limited to police authorities etc.

Engine Data Recording

Various operating parameters are continuously monitored and recorded by certain electronic control modules. This data may be downloaded by Lotus Retailers on demand in order to assist with fault diagnosis and identify any vehicle misuse.

Software Updates

As a process of continuous improvement, Lotus may develop updated software which can be installed in your Emira during a visit to your authorised Lotus Retailer.

You should be advised of any updates applicable to your Emira and what systems will be updated, any time that your Emira enters an authorised Lotus Retailer workshop for service or repair.



NOTE: Functionality of some of the vehicle systems could vary after software updating.

HANDBOOK INFORMATION

Vehicle Identification

The V.I.N. (Vehicle Identification Number) is located in 4 separate areas of the vehicle. You may be asked for your V.I.N. when ordering spare parts or when contacting Lotus Cars.

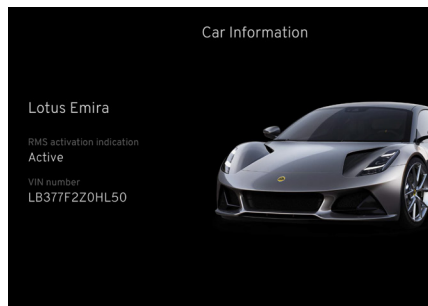

Central Display

From the centre display side bar, select > Global Settings and App Options > General > Car Information. See central display information from page 91.



Windscreen

Attached to the dashboard, viewed from outside of the vehicle at the right-hand side of the windscreen.



Chassis

Stamped on the crossmember beneath the right-hand side seat, accessible with the seat moved rearwards.

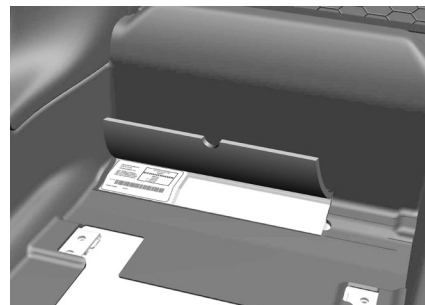

Fuel Tank Bay

Printed label stuck to the floor below the front edge of the right-hand rear of the luggage bay. Pull back a flap in the carpet to view.

VEHICLE OVERVIEW

VEHICLE OVERVIEW

Exterior

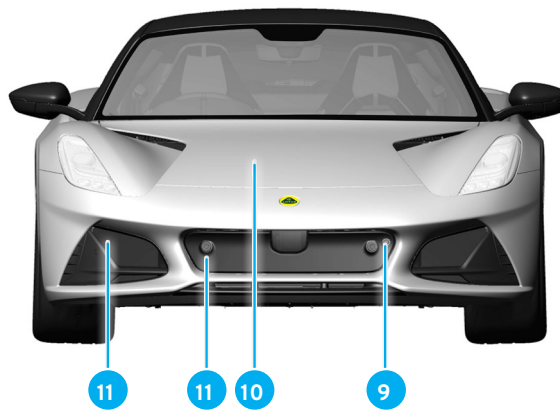
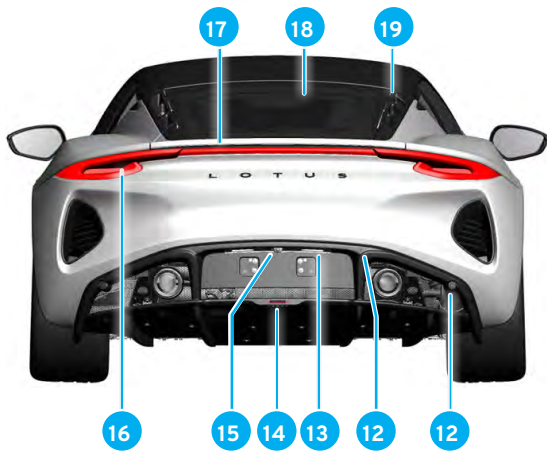
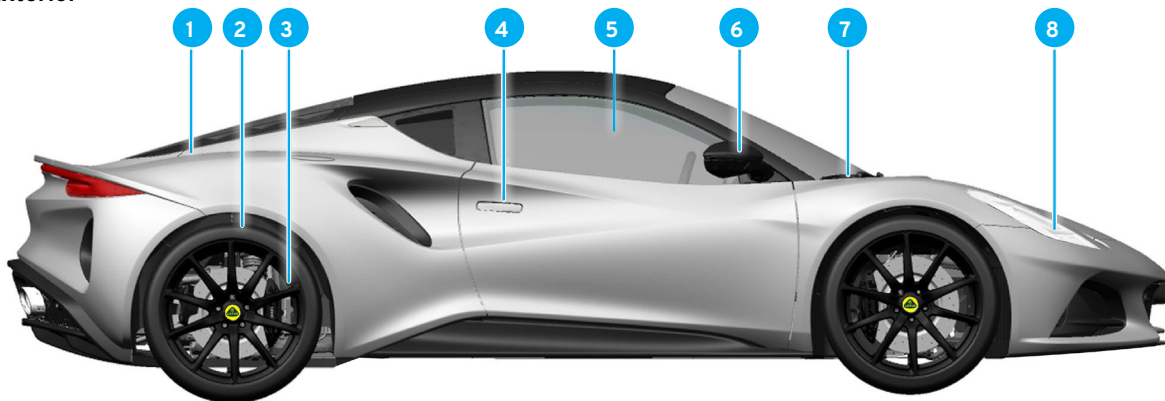

Exterior	Page
1 Fuel filler flap	171
2 Tyres	194
3 Wheels	202
4 Door handle	43
5 Door glass	121
6 Door mirrors	122
7 Windscreen wiper blades	190
8 Exterior lamps - front	223
9 Recovery mounting point	224
10 Front access panel	185
11 Parking sensors - front (fitted both to left and right sides)	86
12 Parking sensors - rear (fitted both to left and right sides)	86
13 License plate lamps	223
14 Reverse/rear fog lamp	223
15 Rear parking assist camera	88
16 Exterior lamps - rear	223
17 Central high mounted brake lamp	223
18 Heated rear screen	139
19 Tailgate	46

VEHICLE OVERVIEW

Cabin Driving Area

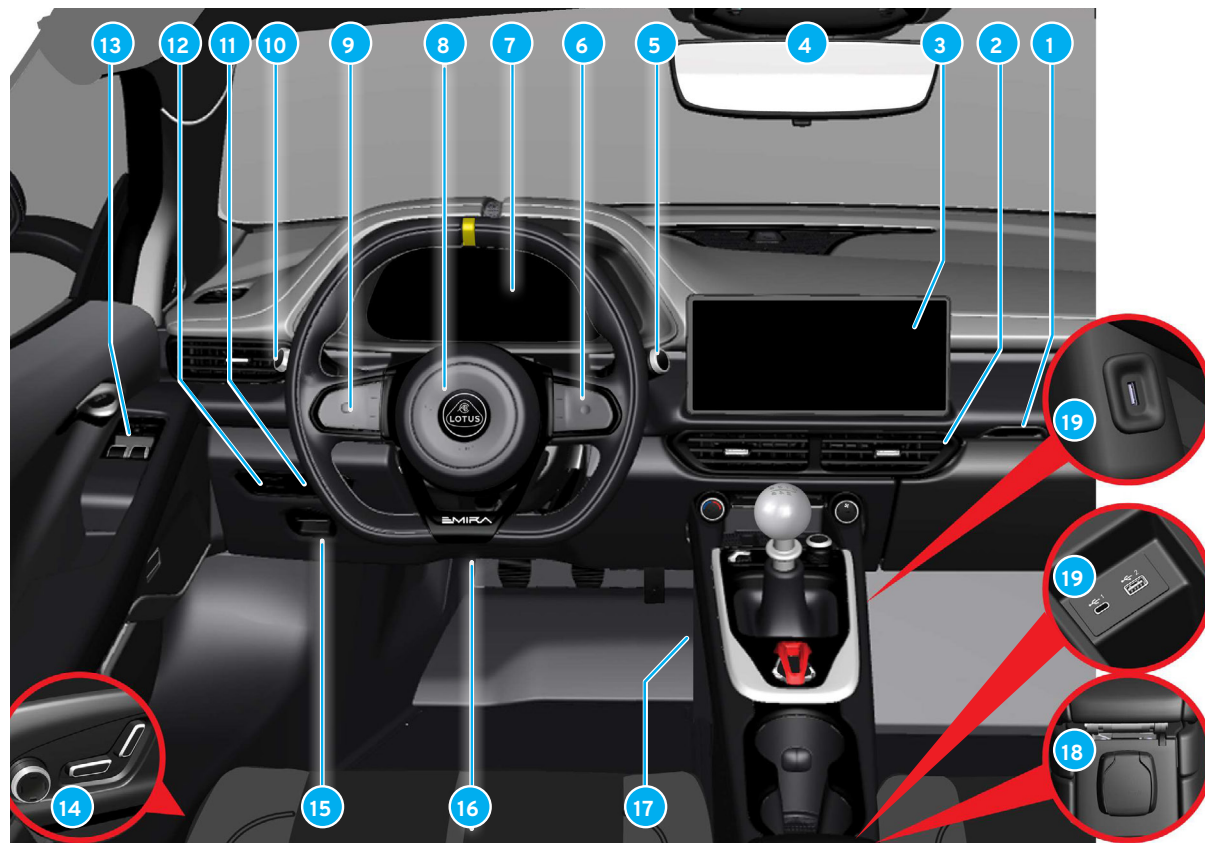

Cabin Driving Area	Page
1 Glove box	127
2 Air vents	141
3 Centre display	91
4 Overhead console/rearview mirror (including USB port)	22/124/130
5 Windscreen wipers/washer	121
6 Right-hand keypad	71
7 Driver display	57
8 Horn	134
9 Left-hand keypad	81
10 Exterior lighting/Trip A reset	111/113
11 Tailgate release	45
12 Display illumination adjustment	117
13 Door control panel	25
14 Seat controls	25
15 Electric parking brake	162
16 Steering column adjuster	134
17 Centre console controls	24
18 Auxiliary power socket	129
19 USB ports in armrest	129

VEHICLE OVERVIEW

Overhead Console

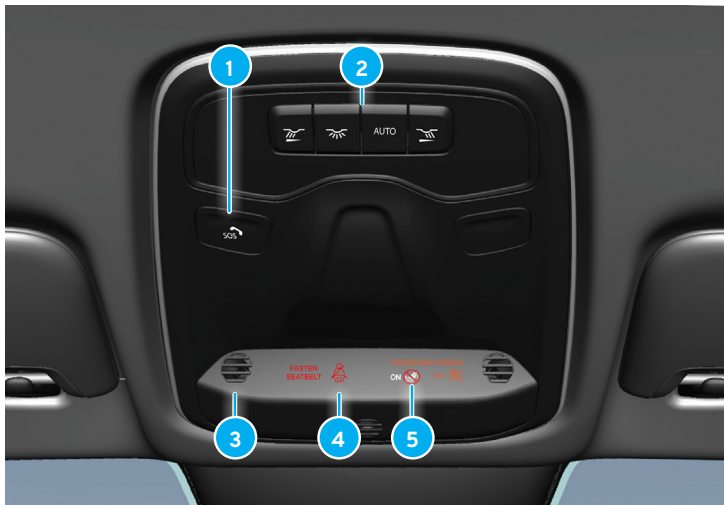



	Page
1 Emergency (SOS) assistance call button*	177
2 Interior lighting buttons	116
3 Microphone	79
4 Passenger airbag status indicator	35
5 Seat belt status indicator	30

* If equipped.

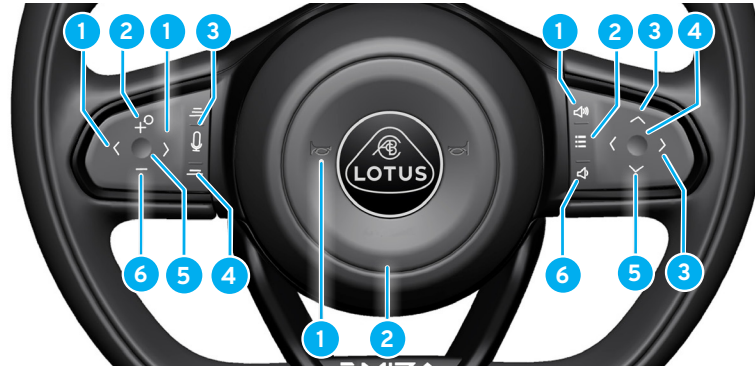





Steering Wheel Switches









Centre Pad

- 1  Horn page 134
- 2  Driver airbag page 34

Left Hand Keypad Switches

- 1  Left/right scroll Page 81
- 2  Resume/increase vehicle speed Page 82
- 3  Voice commands Page 95
- 4  Adaptive cruise control (if fitted)
- 5  Scroll and confirm Page 81
- 6  Decrease vehicle speed Page 82

Right Hand Keypad Switches

- 1  Volume increase Page 71
- 2  Menu options Page 71
- 3  Up/down scroll Page 71
- 4  Scroll and confirm Page 71
- 5  Left/right scroll Page 71
- 6  Volume decrease Page 71

VEHICLE OVERVIEW

Centre Console Controls

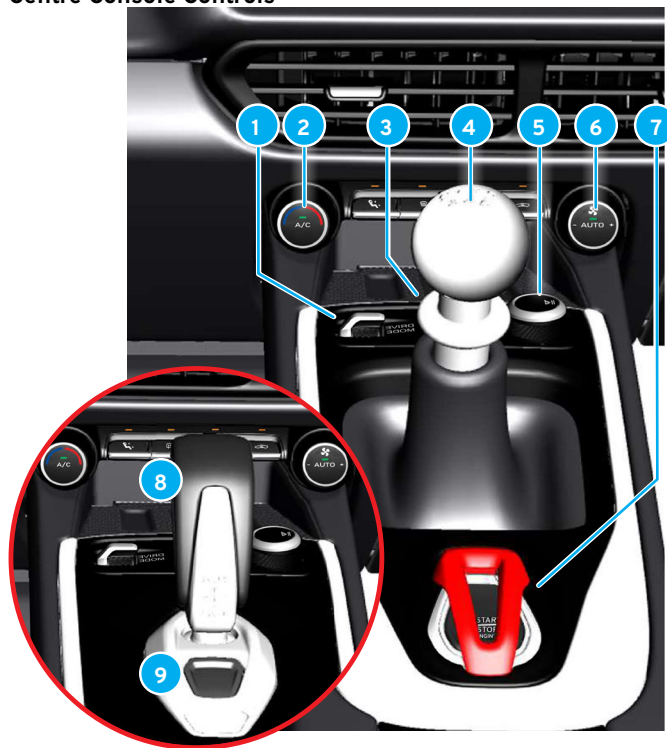

		Page
1	Drive mode selection switch	164
2	Air temperature and A/C switch	137
3	Hazard warning lights	113
4	Manual gear shift lever	151
5	Volume/play/pause button	93
6	Auto climate and fan switch	140
7	Engine start/stop button	150
8	Automatic gear selector	153
9	P - Park button	154

Door Panel Control Switches



- | | Page |
|---|------|
| 1 Door unlock button | 44 |
| 2 Door lock button | 44 |
| 3 Door mirror adjustment buttons/toggle | 122 |
| 4 Power door window switches | 121 |
| 5 Seat memory switches (if fitted) | 133 |



SAFETY

Seatbelts

⚠ WARNING: Heavy braking may result in serious personal injury if the seatbelts are not used.

Inertia Reel Seat Belts

Inertia reel seat belts allow forward movement of the upper body under normal driving conditions, but the belt will lock automatically during braking, acceleration, cornering forces, or on impact in a collision. Locking will also occur if the vehicle is tilted in any direction.

Seat Belt Pretensioners

A severe frontal impact sufficient to trigger the airbag system activates pretensioners within both front seat belt retractors, tightening the belts to increase occupant protection.

⚠ WARNING: Seat belts are designed to work with the airbag system. If a seatbelt is not used or is used incorrectly, this may diminish the protection provided by the airbag in the event of a collision.

⚠ WARNING: It is essential to replace the entire seat belt assembly and check the seat belt anchorage points if the vehicle has been subjected to a severe impact, even if damage to the assembly is not obvious. The seat belt should be replaced if webbing becomes frayed, contaminated, or damaged. Inspect regularly.

⚠ WARNING: No one should travel in a seat with an inoperative seat belt.

⚠ WARNING: Not checking or maintaining seat belts can result in them not working properly when needed. Check the belts regularly and have any problem corrected immediately.

⚠ WARNING: No modifications or additions should be made to the seat belts.

⚠ WARNING: Do not insert any foreign objects into a buckle. In the event of a collision the seatbelts may not function as intended.

Wearing a Seat Belt

Before driving, ensure that the driver and passenger always wear seat belts and wear them properly.

Ensure that you are seated comfortably and the vehicle controls, foot pedals and steering wheel are within easy reach, see page 132.

Fitting





1. Sit erect and fully back in the seat. Hold the seat belt tongue, pull it across the body and withdraw the belt from the retractor.
2. Lay the belt over the body before pushing the belt tongue into the buckle lock at the inboard side of the seat until a positive 'click' is heard.

SAFETY

3. Pull on the belt to check for correct latching and ensure that the belt fits firmly against the body with all the slack taken up by the reel.

The belt should be worn low across the front of the pelvis (not over the abdomen) and across the chest and shoulder.

 **WARNING:** Ensure that no part of the belt is twisted or is entangled in the door or seat mechanism.

 **WARNING:** Never use one belt around two people or allow a child to be carried on a driver's or passenger's lap.

 **WARNING:** Do not clip or hook the seatbelt to hooks or other interior fittings, as this will prevent the belt from tightening properly.

 **WARNING:** Improperly positioning the seat belts can cause serious injury or death in a crash.

Releasing



Press the red button on the belt buckle, then let the belt retract.

If the belt does not fully retract, feed it back into the reel by hand so that it is not loose.

Fitting During Pregnancy

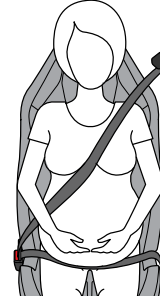

Pregnant drivers should always wear seat belts to protect both themselves and their unborn child.

The diagonal section of the belt should wrap over the shoulder and then be routed between the breasts and to the side of the abdomen.

The lap belt portion of the belt should be kept as low as possible under the abdomen and it must not be allowed to ride upward. Remove any slack from the reel, ensuring it fits as close to the body as possible.

Pregnant drivers must adjust the seat and steering wheel positions to maintain the largest distance possible

between abdomen and steering wheel, but ensuring that the foot pedals and steering wheel can still be easily operated whilst driving.

To maintain control of the vehicle as pregnancy progresses, further seat and steering wheel adjustments may be required.

A doctor should regularly be consulted as to the advisability of driving during pregnancy.

Door/Seat Belt Reminder

The reminder alerts unbelted occupants to wear a seatbelt.

Driver's Display

The graphic in the driver's display will highlight which seats are occupied and also if the seat belts are belted or unbelted.

With the engine running, the display will also warn if a door, front access panel or tailgate is open. The display indicating the opening to be closed will turn red if the vehicle is moving.

The graphic can be extinguished by pressing the central 'O'/confirm button on the right-hand steering wheel keypad.



If the vehicle is driven at a speed lower than 10 km/h, then the information symbol in the driver's display will illuminate.



If the vehicle is driven at a speed higher than 10 km/h, then the warning symbol in the driver's display will illuminate.

If the graphic and information or warning symbol is displayed, stop the vehicle as soon as it is safe to do so and close the opening indicated.

SAFETY



Overhead Console

A visual and audible reminder alert the vehicle occupants if a seatbelt is not being worn. The audible reminder is dependent on vehicle speed.

Child Safety

Statistics show that children are safer when properly restrained in the back seat of a vehicle, an option unavailable in this vehicle. In addition, a passenger airbag is fitted, producing a serious risk to children - particularly infants and small children. If a child is to be carried in the vehicle passenger seat, the following notes are provided for guidance:

The standard seat and seat belt should be used when a child is of a physical size that the standard fitment lap and diagonal seat belt will fit satisfactorily, with the belt positioned over the collar bone and against the centre of the chest.

All children regardless of age and size must always sit correctly secured in the vehicle. Never allow a child to sit on the knee of the passenger.

Child Restraints

A suitable booster cushion or child seat should be used if the belt touches or crosses the child's neck or if required by law. This advice also applies to any adult of small stature.

Suitable Child Seats

Only universal child seats are suitable for the Emira. See page 32 for further information.

Child Seat Installation

Front Facing Child Seat

When fitting a front facing child seat, ensure that the passenger airbag is activated, see page 35.

Rearward Facing Child Seat

Children who are unable to sit up by themselves unsupported must be carried only in rearward facing child seat.



When fitting a rearward facing child seat, ensure that the passenger airbag is deactivated, see page 35.

WARNING: Never use a rearward facing child seat on the passenger seat if the airbag is active.



A warning label for the passenger airbag system is located on the passenger side of the headlining above the windscreen, or on the sun visor if fitted.

WARNING: Front-facing passengers (children and adults) must never sit on the passenger seat if the passenger airbag is deactivated.

WARNING: Never allow anybody to stand or sit in front of the passenger seat.

WARNING: Failure to follow the information given regarding seat belts, child seats and airbag systems can endanger life or lead to serious personal injury.

NOTE: When using child safety equipment, it is important to read the installation instructions included and fit the equipment properly. In the event of questions when fitting child safety equipment, contact the manufacturer for further information.

NOTE: Never leave a child seat loose in the vehicle. Always secure it in accordance to its installation instructions, even when it is not in use.

NOTE: Long-term fitment of a child seat may cause wear to the vehicle seat and interior which is not covered by the vehicle warranty.

SAFETY

Suitable Child Seats

Only universal child seats are suitable for the Emira. 'Universal' means the seat is approved for installation in all cars, although you should check that the child seat you select fits well in the passenger seat of your Emira. The table indicates the installation options for a universally approved child seat fixed with the Emira 3-point seat belt.

Seat Position Number	Seating Position								
	1	2	3	4	5	6	7	8	9
Seating position suitable for universal belted (yes/no)	YES	N/A	YES	N/A	N/A	N/A	N/A	N/A	N/A
i-Size seating position (yes/no)	N/A	N/A	N/A	N/A	N/A	N/A	N/A	N/A	N/A
Seating position suitable for lateral fixture (L1/L2)	N/A	N/A	N/A	N/A	N/A	N/A	N/A	N/A	N/A
Largest suitable rearward facing fixture (R1/R2X/R2/R3)	N/A	N/A	N/A	N/A	N/A	N/A	N/A	N/A	N/A
Largest suitable forward facing fixture (F2X/F2/F3)	N/A	N/A	N/A	N/A	N/A	N/A	N/A	N/A	N/A
Largest suitable booster fixture (B2/B3)	N/A	N/A	N/A	N/A	N/A	N/A	N/A	N/A	N/A

Passenger Seat needs to be fully rearward, seatback angle 25 degrees and seat raised 10mm up from lowest position prior to installation of child restraint.

Seat Number	Position in the Vehicle
1	Front left
2	Front centre
3	Front right
4	2 nd row left
5	2 nd row centre
6	2 nd row right
7	3 rd row left
8	3 rd row centre
9	3 rd row right

Airbag Safety System

In conjunction with wearing seat belts, the airbag system gives the vehicle occupants additional protection in the event of a severe collision.

Airbags are designed to work with the seat belt system. If a seatbelt is not used or is used incorrectly, this may diminish the protection provided by the airbag in the event of a collision.

 **WARNING:** Vehicle occupants can be killed or seriously injured in a crash if they are not wearing a seat belt - even with airbags fitted.

The main components of an airbag system are:

- Electronic monitoring system (SRS control module and sensors).
- Driver airbag.
- Passenger airbag.
- Driver and passenger side airbags.
- Driver and passenger inflatable curtains.
- Pretensioning seat belts.

Airbag Warning Lamp



A fault has been detected in the airbag safety system if this warning lamp illuminates whilst driving. This could mean that one or more of the airbags may not activate in the event of a collision.

 **WARNING:** If the airbag warning lamp does not illuminate as the ignition is turned on, or remains illuminated for more than a few seconds, have the fault rectified immediately by your approved Lotus Retailer. Ignoring the lamp could result in the airbags or belt pretensioners not operating when needed.

 **WARNING:** Do not use any electrical test equipment or modify the wiring for any electrical accessories in the vicinity of SRS components or wiring harnesses. Doing so may disable the airbag system or cause its unintended deployment and result in personal injury.

Seat Belt Pretensioners

A severe frontal impact sufficient to trigger the airbag system activates pretensioners within both front seat belt retractors, tightening the belts to increase occupant protection.

SAFETY



Driver and Passenger Airbags

The driver's airbag is fitted into the centre of the steering wheel. The passenger airbag is fitted into a compartment above the glovebox. The cover panels for both airbags are marked 'AIR-BAG'.

In a severe frontal collision, the airbags inflate in a fraction of a second to provide protection for the upper body of the occupants.

Dependent upon the angle of collision (front or near frontal) the driver and passenger airbags may activate without activating any other airbags.

The airbags deflate rapidly during the collision to minimise any obstruction to

the occupants and reduce any danger of suffocation. During deflation it is normal for smoke to escape from the airbag.

WARNING: A passenger will minimise their chances of injury if an airbag deploys in a frontal collision if they sit as upright as possible with their feet on the floor and backs against the seat backrest.

Always hold the steering wheel by the outer rim. Never rest your hands on the airbag cover or attach anything to the steering wheel hub.

Do not put objects in front of or above the dashboard where the passenger airbag is located.

WARNING: The path of an inflating airbag must be kept clear. If an object is placed between a person and an airbag, the airbag might not inflate properly, or it might force the object into that person causing death or serious injury.



Passenger Airbag Label

A warning label for the passenger airbag system is located on the passenger side of the headlining above the windscreen, or on the sun visor if fitted.

WARNING: Never use a rearward facing child seat on the passenger seat if the airbag is activated.

WARNING: A front facing passenger (child or adult) must never sit on the passenger seat if the passenger airbag is deactivated.



Passenger Airbag Switch

(Right-Hand Drive glovebox shown)
A switch is located in the glovebox to deactivate/activate the passenger front airbag. The switch is accessible only with the glovebox open.

- A ON** - The airbag is activated and all front facing passengers (children and adults) can sit safely on the passenger seat.
- B OFF** - The airbag is deactivated and children in rearward facing child seats can sit safely on the passenger seat.



Deactivating Passenger Airbag

- 1** Pull the switch outward.
- 2** Turn it from ON to OFF position.

The driver display shows a message that the passenger airbag is deactivated.

Confirm the message by pressing the central **O**/confirm button on the right-hand steering wheel keypad, see page 61 for further information.

⚠ WARNING: A front facing passenger (child or adult) must never sit on the passenger seat if the passenger airbag is deactivated.





The upper console also shows a message and symbol informing that the passenger airbag is deactivated.

📖 NOTE: If the passenger airbag has been deactivated with the vehicle in ignition position I or lower, the messages will appear approximately 6 seconds after the ignition is put into position II.

SAFETY





Activating Passenger Airbag

-  1. Pull the switch outward.
-  2. Turn it from OFF to ON position.

The driver display shows a message that the passenger airbag is activated.

Confirm the message by pressing the central /confirm button on the right-hand steering wheel keypad, see page 61 for further information.

 **WARNING:** Never sit a child on a booster cushion. Never use a rearward facing child seat on the passenger seat if the airbag is activated.

 **WARNING:** The passenger airbag must always be activated when a front facing passenger (child or adult) is sitting in the front passenger seat.



The upper console also shows a message and symbol informing that the passenger airbag is activated.

 **NOTE:** If the passenger airbag has been activated with the vehicle in ignition position I or lower, the messages will appear approximately 6 seconds after the ignition is put into position II.



Side Airbags

A side airbag is fitted into the outboard side of both seat backrests, identified by the word 'AIRBAG'.

If the vehicle is involved in a moderate to severe side collision, the side airbags deploy between the occupant and the door panel.

 **NOTE:** The side airbags may not deploy in all side impact situations.

The airbags deflate rapidly during the collision to minimise any obstruction to the occupants and reduce any danger of suffocation. During deflation it is normal for smoke to escape from the airbag. The seat belt pre-tensioners will also activate at the same time.

WARNING: Never drive with your arm or head out of the window as this will place your arm, head and neck in the path of the side airbag deployment area.

WARNING: Do not place any objects between the side airbag and the door as the airbag might not inflate properly, or it might force the object into the cabin area causing death or serious injury.

WARNING: Do not attach or put anything on the side airbag cover as this may cause the airbag not to inflate properly.

Side Airbags and Child Seats

The protection provided by the airbag system to a child seated in a child seat or on a booster cushion is not diminished by the side airbag.



Inflatable Curtains

An inflatable curtain is mounted along both sides of the headlining and helps protect the driver and outer seat passengers of the vehicle. The panels are labelled with 'IC AIRBAG'.

If the vehicle is involved in a moderate to severe frontal, side collision and/or vehicle roll-over, the inflatable curtain is deployed to prevent the occupant from striking their head on the inside of the vehicle during a collision.

The airbags deflate rapidly during the collision to minimise any obstruction to the occupants and reduce any danger of suffocation. During deflation it is normal for smoke to escape from the airbag.

NOTE: The inflatable curtain may not deploy in all side impact situations.

WARNING: Do not screw or install anything onto the vehicle's roof lining, door pillars or side panels. This could compromise the intended protection.

WARNING: Do not overload the cargo area behind the seats to a level higher than 10 cm below the upper edge of the rear side quarterlight windows. Objects placed higher than this level could impede the function of the inflatable curtain.

SAFETY

Safety Mode

Safety mode is activated if one or more of the safety systems such as the airbags or seat belt pre-tensioners have deployed. The collision may have damaged an important function in the vehicle, such as the fuel/braking system or sensors for one of the safety systems etc.

If the vehicle has been in a collision, but the driver's display and the vehicle's electrical system is still functioning, the message 'Safety Mode See Owner's Manual' and a warning symbol may be shown in the driver's display. When in Safety Mode, the vehicle's has reduced functionality.

 **WARNING:** Never attempt to restart the vehicle if you detect the smell of fuel or see any signs of fuel leakage. Leave the vehicle immediately.

Dependent upon the damage to the vehicle, it may be possible to reset the system to start and move the vehicle for the shortest distance possible, (such as to move the vehicle away from a dangerous traffic situation).

 **WARNING:** The vehicle should be inspected after any collision by a Lotus Retailer. Some of the functions may have been lost even if the vehicle does not appear to be damaged.

 **WARNING:** If the vehicle is in safety mode it must not be driven or towed. It must be transported on a flatbed recovery truck to a Lotus Retailer for inspection/repairs.

KEYS, LOCKS & ALARM

KEYS, LOCKS & ALARM

Keys

2 keyfobs are supplied which are used to:

- Lock/unlock the vehicle.
- Arm/disarm the vehicle alarm system, see page 53.
- Keyless engine starting when a valid keyfob is inside the passenger compartment, see page 149.
- Manually lock/unlock the doors using the removable key blade if required.



Keyfob Storage

If only one keyfob is being used, then the other keyfob should be kept in a safe place and a replacement obtained immediately if either are lost.

Ordering Additional Keyfobs

Additional keyfobs and key blades can be ordered and programmed by a Lotus Retailer.

Lost or Stolen Keyfobs

If a keyfob or key blade are lost, any others should also be taken to a Lotus Retailer so that the code of the lost remote control key is erased from the vehicle system for anti-theft purposes. The replacement of the vehicle's door lock is also recommended to maintain full vehicle security.

 **WARNING:** Always switch off the ignition and do not leave the keyfob in the cabin when leaving the vehicle.

 **WARNING:** Never leave the vehicle unattended with the keyfob in the cabin, especially if unsupervised children and/or animals are in the vehicle.

 **CAUTION:** Do not modify the keyfob or strike hard objects with it as this could affect its functionality. Problems with the keyfob as a result from this will not be covered under the terms of the vehicle warranty.

Keyfob Reminder

A keyfob must be in the vehicle cabin to activate the ignition modes and start the engine. If a keyfob is not detected a message is shown in the driver's display.



Key not in car

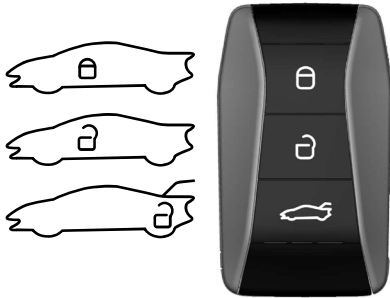

Tailgate: Unlocks the tailgate only and disarms its alarm.

Unlocking Options

Two different unlocking options can be selected.

Both Doors: Single button press unlocks both doors simultaneously.

Single Door: Single press unlocks the driver's door and a second press unlocks the passenger door.

This option can be changed in the central display, see page 55.

Keyfob Range

Normal operation range is up to 20 metres from the vehicle, but this may be reduced by:

- The vehicle being close to a radio/TV tower/mast or a power station.
- Keyfob being near other wireless equipment, such as a mobile phone, a transmitter or a radio.
- Keyfob being touched or is covered by a metallic material.

Keyfob Buttons

 **Locking:** Pressing the button locks both doors, tailgate and fuel filler flap. The alarm is also armed, see page 52.

Press and hold to close all door windows simultaneously.

 **Unlocking:** Pressing the button unlocks the doors, tailgate and fuel filler flap. The alarm is also deactivated, see page 53.

A longer press opens all door windows simultaneously.

This setting can be changed in the central display, see page 55.

- Keyfob being close to an electrical device such as a computer.
- Keyfob internal battery having a low state of charge.
- Environmental conditions.

If the doors do not lock/unlock when a keyfob button is pressed - move closer to the vehicle and try again.



External Locking/Unlocking Confirmation

- Locking: The hazard warning lamps flash once, the door mirrors fold inwards and the daytime running lights will fade on-off.
- Unlocking: The hazard warning lamps flash twice and the door mirrors unfold. Audible feedback of unlocking is also available, see page 55.

KEYS, LOCKS & ALARM

Both doors, tailgate, bonnet and fuel filler flap must be closed to lock the vehicle completely and arm the alarm.



Lock and Alarm Indicator

The indicator on the dashboard flashes to indicate that the vehicle is locked and the alarm is armed, also see page 53.

Lock Indication Settings

Using the settings menu in the central display, it is possible to select different locking feedback response options:

Visible feedback: on - off

Audible feedback: on - off

The door mirrors folding option can also be activated or deactivated, see page 55.

Locking



Ensure that both doors, tailgate and fuel filler flap are closed then press the  button on the keyfob.

- Both doors are locked.
- The interior lamps (if illuminated) will fade off.
- After 10 seconds the fuel filler flap will lock.
- After 45 seconds the engine is immobilised and the alarm activated.
- At this time the lock/alarm indicator will flash once every 2 seconds.

There is no visible or audible feedback if attempting to lock the vehicle when a door is not fully shut, neither door will lock and the alarm will not be armed.

If attempting to lock with the tailgate open, the doors will lock and the alarm will arm but when the vehicle is unlocked the hazard warning lights will not flash.

! **CAUTION:** Do not leave the keyfob in the luggage compartment when closing the tailgate, if the rest of the vehicle is locked and armed, as closing the tailgate will then completely lock the vehicle. The other keyfob will be required to unlock the vehicle.

Unlocking



Press the  button on the keyfob.

- Both doors* and the fuel flap will unlock.
- The lock/alarm indicator on the dashboard will stop flashing**.
- The alarm is disarmed and engine will be mobilised.
- The interior lamp will fade on (if set to the 'courtesy' position), see page 116.

* Depending on the locking option selected, see page 55.

**Unless a theft attempt has been detected, see page 52.

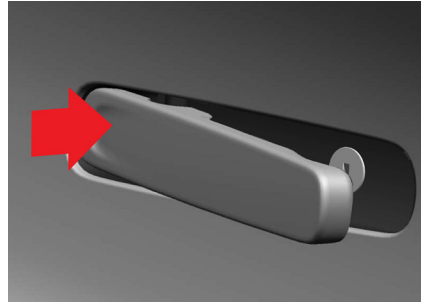

Opening a Door from the Outside

With the vehicle unlocked:

- Press the front of the door handle.
- The rear of the handle will pivot outwards.
- Pull the rear of the handle to open the door.

Automatic Relocking

The vehicle is automatically relocked and the alarm re-armed if a door or tailgate is not opened within 2 minutes of unlocking. This ensures that the vehicle does not remain unintentionally unlocked.

Automatic Locking

When the vehicle reaches a certain speed, the doors and tailgate will lock automatically see page 55 for setting options.

Keyfob Does Not Work

Try moving closer to the vehicle and try another unlock attempt.

Refer to page 51 if the remote control key will not lock or unlock the doors.

Unlocking in an Accident

To aid access in the event of an accident that has deployed the airbags, a door locked from the inside the cabin will unlock automatically, (if possible).

KEYS, LOCKS & ALARM

Interior Door Locking/Unlocking



Door Switches

The doors can be locked and unlocked using the central locking switch in the driver's door panel.

Press the  button to unlock both doors, also see page 41.

With both doors closed, press the  button to lock.

Drive-Away Locking

This selectable option will automatically lock the doors when vehicle speed exceeds 3 mph (5 km/h). The doors will remain locked until an interior door release handle is pulled or the interior central door locking  button is pressed. This option can be selected from the centre display, see page 55.

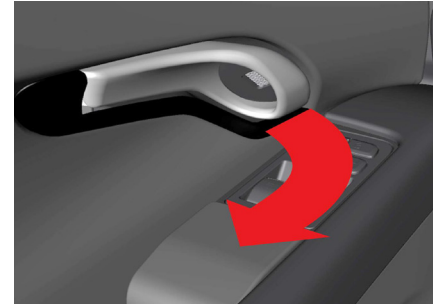

Unlocking – Door Release Handle

To unlock from the inside, pull a door release handle and release, a second pull will open the door.

Tailgate Opening Using Keyfob

A press (1.5 - 2 seconds approximately) of the  button on the keyfob will unlatch the tailgate and unlock and fuel filler flap.

- The tailgate can now be lifted open.
- The doors remain locked and the alarm armed.
- The lock and alarm indicator on the dashboard extinguishes to indicate that the vehicle is not completely locked.

When closing the tailgate, ensure that the keyfob has not been placed within the luggage compartment.

The alarm system will return to its previous state when the tailgate is closed.

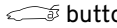

NOTE: A short press of 0.5 seconds (approximately) of the  button on the keyfob will unlock the fuel filler flap whilst leaving the tailgate latched closed.



CAUTION: Do not leave the keyfob in the luggage compartment when closing the tailgate if the rest of the vehicle is locked and armed as closing the tailgate will then completely lock the vehicle. The other keyfob will be required to unlock the vehicle.

**Tailgate Opening Using Switch**

Press and hold the  switch located on the outboard side of the steering column to unlatch the tailgate.

The tailgate can now be opened.



CAUTION: Pressing the switch releases the latching mechanism, therefore if the switch is accidentally pressed, the tailgate must be manually closed before driving or locking the vehicle.

KEYS, LOCKS & ALARM

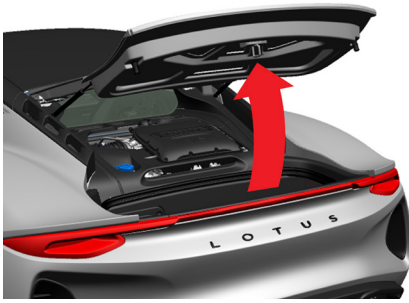

Lifting the Tailgate

With the tailgate unlatched, lift it fully upwards, the struts will assist with lifting and will hold the tailgate in position once fully raised.

⚠ WARNING: The ventilation grilles may become hot, take care to avoid burn injuries. When using the rear luggage compartment, beware of any hot surfaces exposed in the engine bay.

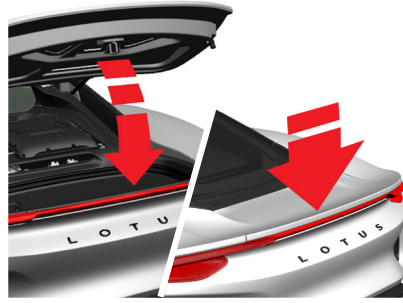

Closing the Tailgate

Pull down the tailgate and press firmly over the centre section of the spoiler ensuring complete engagement of the latch. Do not leave the keyfob in the luggage compartment when closing the tailgate.

Before closing the tailgate, ensure that no persons or objects will be trapped. Also ensure that there are no obstructions that would prevent the tailgate from closing properly.

With the ignition on, a warning will be shown on the vehicle silhouette display within the instrument panel screen if the tailgate is open or not completely closed.

Luggage Weight

For all models the maximum weight of goods which may be carried in the rear luggage compartment is 50 kg.

⚠ WARNING: Exceeding these limits can overload the tyres and affect the handling of the vehicle and result in an accident.

📖 NOTE: If necessary, protect and/or secure luggage as required. Allowing sharp edged or heavy items to slide or roll around the luggage compartment may cause body damage which will not be covered by the vehicle warranty.

⚠ CAUTION: Do not leave the keyfob in the luggage compartment when closing the tailgate, if the rest of the vehicle is locked and armed, as closing the tailgate will then completely lock the vehicle. The other keyfob will be required to unlock the vehicle.



Emergency Release Handles

Inside Cabin

Open the left-hand door using the mechanical lock if necessary, see page 50.

Pull off the access panel located within the left-hand rear quarter trim panel, behind the left seat.

Pull the handle firmly towards you to release the tailgate latch.

After using the emergency release handle, take extra care to ensure the tailgate is fully closed.



Inside Luggage Compartment

(Child Entrapment)

An emergency release handle is provided if a child should become trapped inside the rear luggage compartment.

The handle at the rear of the compartment should be pulled towards the right hand-side of the vehicle to release the tailgate latch.

Parents should decide if their children should be shown how to use this feature.

Keyfob Removed from Vehicle

A warning symbol and notification message are shown in the driver display screen if the keyfob is removed from the vehicle when the engine is running.



Key not in car

An audible reminder sounds when both doors are closed.

The message extinguishes when the key is returned to the vehicle, or by pressing the steering wheel right-hand keypad's **O** button, or when both doors are closed.

KEYS, LOCKS & ALARM

Keyfob Battery

The usable life of the battery will vary depending on how often the vehicle/key is used.

It is recommended to change the batteries annually. The battery for the keyfob should definitely be replaced if:

- The  symbol warning symbol and notification message are shown in the driver display screen.



Remote key battery low

- The locks repeatedly do not react to signals from the keyfob within 20 metres of the vehicle.



Opening the Battery Case

Prise open the end of the battery cover using a suitable small flat bladed screwdriver and lift the cover away.

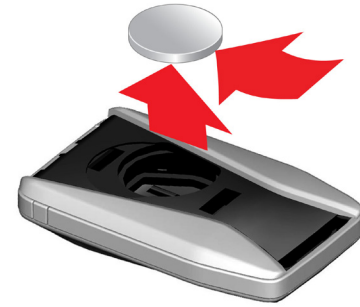

Removing the Battery

Lifting the battery up from its edge, remove it from the keyfob.



Installing a New Battery

Ensure the battery is facing with the (+) side upwards. With the edge of the battery slightly downwards, place the battery into the battery holder.

! **CAUTION:** Avoid touching the electrical contact surfaces on new batteries with your fingers as this may impair its function or reduce its usable life.

! **NOTE:** Replace only with a 3V, CR2032 type battery.



Closing the Battery Case

Slide the hooked lipped end of the battery cover into the slots at the end of the keyfob case, then close the battery cover back into place, a clicking noise indicates that the cover is securely closed.

! **WARNING:** Check that the battery is fitted correctly. If the remote control key will not be used for a long time period, remove the battery to avoid battery leakage and damage. Damage or leaking batteries may cause corrosive injury on contact with the skin. Always use protective gloves when handling damaged batteries.

! **WARNING:** Keep batteries out of the reach of children and pets as they can be swallowed.

! **WARNING:** Batteries must not be dismantled, short-circuited or thrown into open flames.

! **WARNING:** Do not attempt to charge non-rechargeable batteries, this may cause an explosion.

! **WARNING:** Check the remote control key for any damage before use. If damage is discovered, such as if the battery cover cannot be closed properly, then the key should not be used. Keep defective products out of the reach of children.



Only dispose of the battery at an official recycling collection point. Do not dispose of with any other general household waste.

KEYS, LOCKS & ALARM

Emergency Key Blade

The keyfob contains a detachable key blade which can be used in the event of a vehicle electrical, keyfob or vehicle electrical failure so that the left-hand side door can be unlocked manually to gain access to the vehicle cabin.

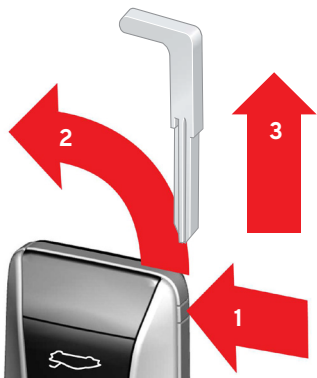

Removing the Key Blade

- 1 Press and hold the release button on the side of the keyfob, (a suitable pointed object may be required).
- 2 The panel at the end of the keyfob will open.
- 3 Pull the key blade out of the keyfob casing.

- 3 Pull the key blade out of the keyfob casing.

Refitting the Key Blade

Place the key blade back into the keyfob casing, sliding the key blade into the casing until it clicks into place then close the end cover.

Using the Emergency Key Blade

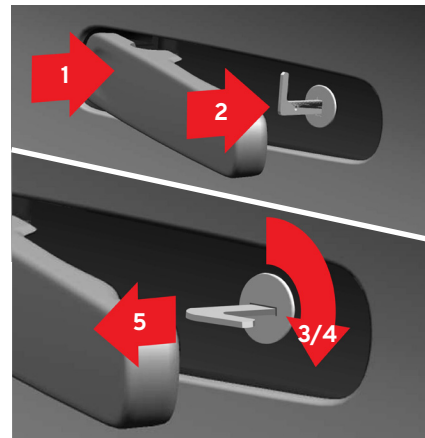

Unlocking the Left-Hand Door

- 1 Press the front of the left-hand side door handle and hold the rear of the handle so that the lock is visible.
- 2 Insert the key blade into the lock.
- 3 Rotate the key blade a quarter turn clockwise so that the end of the blade is pointing rearwards.
- 4 Rotate the key blade counter-clockwise to its starting position.
- 5 The door is unlocked.

5 Remove the key blade from the lock and release the handle so that it is resting against the door.

- Pull the handle and the door will open.
- Once inside the cabin, the right-hand side door can be opened using the interior release handle.

Locking the Left-Hand Door

Perform steps 1, 2, 4 and 5 as shown for unlocking, but rotate the key blade a quarter turn counter-clockwise instead of clockwise as shown in step (3).

NOTE: The right-hand side door will remain in either the locked or unlocked condition the central door locking system was set to prior to keyfob or vehicle electrical failure and cannot be changed until central door locking operation is fully restored.



Deactivating the Vehicle Alarm

NOTE: The alarm is triggered when the door is unlocked and opened using the emergency key blade.

- Place the keyfob in the recess towards the rear of the storage area within centre console arm rest.
- Press the start button.
- The alarm siren will silence and the alarm is deactivated.

See pages 150 onwards for starting the vehicle.

KEYS, LOCKS & ALARM

Alarm

When armed, the alarm is triggered if:

- A door, the bonnet or the tailgate is opened.
- Movement is detected in the cabin (if fitted with a movement detector*)
- The vehicle is raised or towed away (if fitted with a tilt detector*)
- The starter battery cables are disconnected.
- The siren is disconnected.

* If fitted.

Alarm Triggering Signals

When the alarm has been triggered:

- The alarm siren will sound for 30 seconds or until the alarm is deactivated.
- The hazard warning lamps will flash for 5 minutes or until the alarm is deactivated.
- If the cause of alarm triggering is not rectified this alarm cycle is repeated for up to 10 times.

Immobiliser

The immobiliser system prevents an unauthorised person from starting the vehicle. The vehicle can only be started with the correct keyfob.

A warning symbol and notification message are shown in the driver display if either an incorrect key or if no key is detected when attempting to start the engine.



Car key not found



Lock and Alarm Indicator

The flashing rate of the LED on the dashboard indicates the alarm system's status.

Flashing Rate Alarm Status

Not flashing: Not armed.

Every 2 seconds: Armed.

Rapidly after dis-arming: Alarm has been triggered, the LED flashes rapidly for a maximum of 30 seconds or until ignition position I has been activated, see page 149.

Movement and Tilt Sensors

If fitted, these sensors react to movements inside the vehicle, or if anyone tries to raise or tow away the vehicle.

The movement sensor triggers the alarm if movement is detected within the vehicle cabin. Because air currents are also detected as movement, the door windows should be closed when locking the vehicle/arming the alarm.

The movement and tilt sensors should be deactivated when the vehicle is being transported, (such as by recovery transporter, train or ferry), as movements whilst being transported may trigger the alarm.

To temporarily deactivate the movement and tilt sensors, see 'Reduced Alarm Level' on page 95.

Alarm System Fault

A warning symbol and notification message are shown in the driver display if a fault is detected within the alarm system.



Alarm system sensor fault

If displayed contact an authorised Lotus Retailer.

Arming the Alarm



Ensure that both doors and the tailgate are closed then press the  button on the keyfob.

- Both doors are locked, the immobiliser is activated and the alarm is armed.
- The lock and alarm indicator will flash once every 2 seconds, see page 52.

Disarming the Alarm



Press the  button on the keyfob.

- The doors will unlock*.
- The lock/alarm indicator on the dashboard will stop flashing*.
- The alarm is disarmed and engine will be mobilised.

* Depending on the locking option selected, see page 55.

KEYS, LOCKS & ALARM

**Unless a theft attempt has been detected, see page 52.

Lotus Vehicle Tracker

If fitted, the Lotus Vehicle Tracker is supplied with 2 driver identification tags. If the vehicle is moved without any tags present (in the event of key cloning or key theft) or if the vehicle battery is disconnected, the tracker alerts Scorpions' UK based 24/7/365 monitoring centre.

In an alert event the vehicle is live tracked and the vehicle's owner is contacted. Refer to the user guide for further information.

Switching off a Triggered Alarm



Either:

- Press the  button on the keyfob.
- Set the vehicle in ignition position I by pressing the start button, see page 149.

Automatic Re-arming

The vehicle is automatically relocked and the alarm re-armed if a door or tailgate is not opened within 2 minutes of unlocking. This ensures that the vehicle does not remain unintentionally unlocked and the alarm system disarmed.

In certain markets, the alarm is armed automatically after a certain delay after the driver's door has been opened and closed without being locked.

This setting can be changed in the central display, see page 55.

Reduced Alarm Level

This allows the movement and tilt sensors to be temporarily deactivated.

Deactivation may be required when a person or animal is to be left in the locked vehicle or if the vehicle is being transported, (such as by recovery transporter, train or ferry), as movements may trigger the alarm.

This setting can be changed in the centre display, see page 55.

If the doors remain closed after the unlock and are then relocked, the alarm will continue to remain in the reduced alarm level state.

Alarm/Locking Preset Options

From the Global Settings and App Options button side bar in the centre display, select: Car > Security.

See page 91 for further information.

DISPLAYS, WARNINGS AND GAUGES

Driver Display

Tour and Sport Mode Displays

- 1 Driver support menu, 81.
- 2 Tachometer (RPM), 64.
- 3 Performance gear shift & launch control indicator, 65 & 68.
- 4 Speedometer, 64.
- 5 Widget options & notifications, 71.
- 6 Gear selected & drive mode, 67 & 67.
- 7 System status & warning lamps, 58.
Direction indicators, 112.
- 8 Outside air temperature, 64.
- 9 Engine coolant temperature, 63.
- 10 Fuel gauge, 62.
- 11 Clock, 63.

For central display see page 91.

Tour Mode

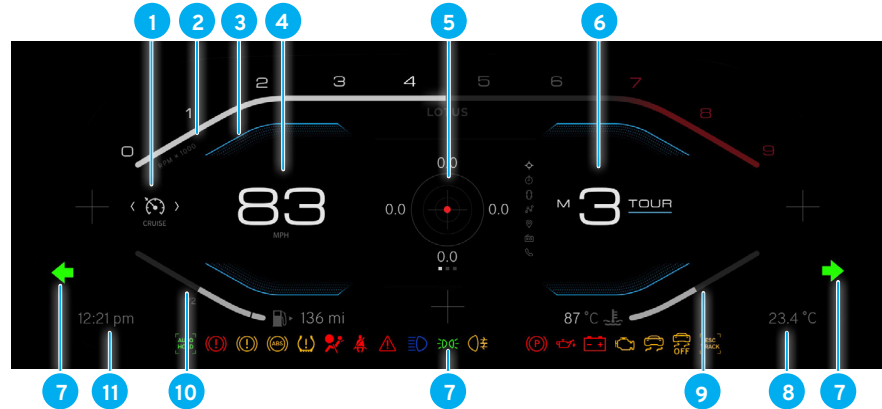

Sport Mode



DISPLAYS, WARNINGS AND GAUGES

Track Mode

(If equipped)

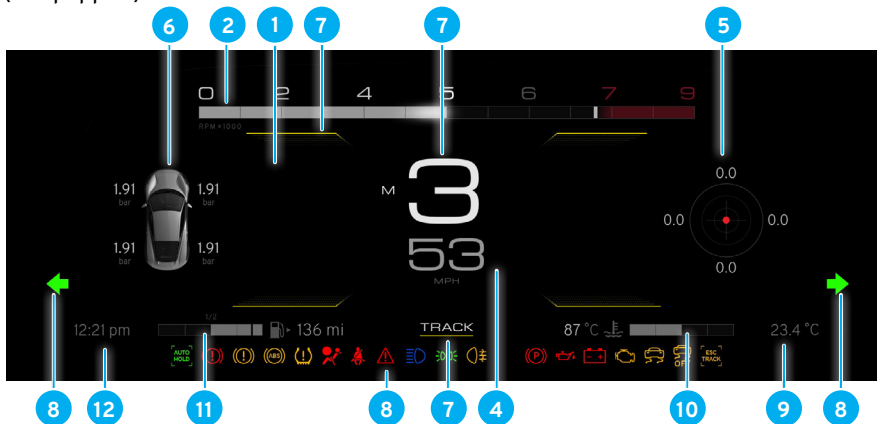

1 Driver support menu, 81.

2 Tachometer (RPM), 64.

3 Performance gear shift & launch control indicator, 64 & 68.

4 Speedometer, 64.

5 Widget options & notifications, 71.

6 Track widget 73.

7 Gear selected & drive mode, 67 & 67.

8 System status & warning lamps, 58. Direction indicators, 112.

9 Outside air temperature, 64.

10 Engine coolant temperature, 63.

11 Fuel gauge, 62.

12 Clock, 63.

Indicator Symbols

These are positioned within the instrument panel, which are used to indicate either:

Status: A system or control has been selected, (such as turn signals, cruise control etc).

Warnings: Potential vehicle system faults, (such as low brake fluid level, engine oil level etc).





Indicator Check





To check that all warning systems are operative, symbols used for warning alerts illuminate for approximately 3 - 6 seconds when in ignition mode II, see page 149. If any indicator fails to illuminate contact your Lotus Retailer immediately.



Warning Symbol Illumination

A warning symbol flashing constantly or permanently illuminated whilst driving may indicate a fault in the operation of the system concerned. Do not ignore any illuminated warning lights; contact your Lotus Retailer immediately.

System Status Indicator Symbols



Symbol	Description
	Information/Notifications Illuminates amber in conjunction with text and other symbols on the driver display
	Parking Brake Illuminates red when the parking brake has been applied. Page 162.
	Auto Hold Illuminates green when the brake auto hold function is activated, Page 163.
	Left & Right Hand Direction Indicator Flashes green when the direction indicators or hazard lights are active. Page 112.
	Position and Low Beam Lamps Illuminates green when the position and low beam lamps are active. Page 111.



Symbol	Description
	Electronic Stability Control Off Illuminates amber if the stability program has been manually turned off. Page 161.
	ESC Track Illuminates amber with track driving mode selected. Page 164.
	Seatbelt Reminder Illuminates or flashes red if a seat belt is not fastened. Page 29.
	Passenger Airbag On Illuminates red to indicate that the passenger airbag is activated and an adult can sit safely in the passenger seat. Never sit a child on a booster cushion. Never use a rearward facing child seat on the passenger seat if the airbag is activated. Page 35.

Symbol	Description
	Passenger Airbag Off Illuminates amber to indicate that the passenger airbag is deactivated and a child in a rearward facing child seat can sit safely on the passenger seat. Page 35.
	Low Fuel Level Illuminates amber indicating a low fuel level in the fuel tank. Page 62.



DISPLAYS, WARNINGS AND GAUGES



Warning Symbol Illumination

Symbol	Description
	General Warning Triangle Illuminates red in conjunction with other warnings when a fault has been detected which could affect the safety or drivability of the vehicle. An explanatory text may also be shown on the driver display at the same time.
	Brake Fault Illuminates red if the brake fluid level is excessively low or a fault is detected in the braking system.
	Illuminates amber to indicate if a fault in the electronic parking brake system is detected.

Symbol	Description
	Anti-Lock Braking System (ABS) Illuminates amber if the system is not operating. The vehicle's regular braking system will continue to operate but without the ABS function. Page 160.
	Oil Pressure Illuminates red. If the light fails to go out after engine start up, or comes on when the engine is running, stop the engine immediately or when it is safe to do so. Do not restart until the cause has been rectified.
	Battery Charging Illuminates red if the battery is not being charged when the engine is running. Stop the vehicle as soon as safely possible and turn off the engine immediately as engine cooling may also be affected and could cause the engine to overheat very quickly.

Symbol	Description
	Malfunction Illuminates amber. If illuminated continuously whilst driving, a fault in the vehicle's emission system is detected. Reduce speed immediately and seek Lotus Retailer advice without delay. Avoid all unnecessary journeys. Flashes when a fault occurs that could cause overheating damage to a catalytic converter. Slow down immediately and prepare to stop. If the lamp stops flashing and is illuminated continuously, proceed with caution and seek Retailer advice. If the lamp continues to flash, stop the vehicle as soon as it is safe to do so and switch off the engine. Seek Lotus Retailer advice.

Symbol	Description
	Airbags Illuminated red. If the lamp remains illuminated or illuminates whilst driving, a fault in the airbag or pre-tensioned seat belt system has been detected, which should be rectified without delay. Page 32.
	Coolant Temperature See page 63 for further information.
	Wiper Fault Illuminates red when a fault in the wiper system is detected. Page 119.

Symbol	Description
	Tyre Pressure System Illuminates amber when a tyre pressure is too low. If selected as a widget option, current pressure and temperature information can also be shown in the driver display. Page 201. If there is a fault in the tyre pressure system, the symbol will flash for approximately 1 minute and then illuminate with a constant glow indicating that the system cannot detect or warn of low tyre pressure as intended.
	Brake Light Fault Illuminates amber when a fault in the brake lights system is detected.
	Direction Indicator Fault Illuminates red when a fault in the direction indicators system is detected. Page 112.

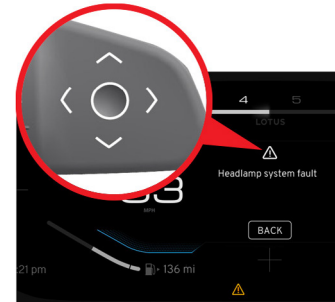

Messages

Certain symbols generate a chime, message and icon overriding either the central or the right-hand side of the driver's display screen.

Messages displayed indicate that either a vehicle system has been activated, vehicle information is available or that a system fault has been detected.

The message will inform the driver of any actions to be taken, such as releasing the parking brake through to stopping the vehicle if necessary.

Some messages may only appear briefly and are then stored as notifications, but any associated message symbols will remain illuminated until the fault is rectified.

DISPLAYS, WARNINGS AND GAUGES

Messages may automatically delete when the fault is rectified or action is taken, (such as refilling the windscreen washer bottle or fitting a seatbelt).

Messages that indicate a severe safety or system malfunction fault will remain constantly displayed until the message is acknowledged by the driver by pressing the  confirm button on the right-hand steering wheel keypad.

See page 77 for viewing stored notifications.

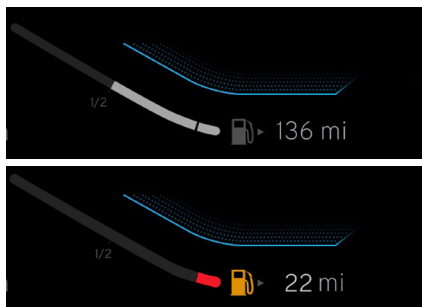

Fuel Gauge

The white zone within the gauge line indicates the quantity of fuel within the fuel tank. As fuel is consumed the length of the white (beige) zone shortens.

The fuel range, the approximate distance that the vehicle can travel calculated on the fuel available is shown next to the  symbol. The average and instantaneous fuel consumption can also be displayed, see page 72.

When approximately only 6 litres of fuel is remaining the  symbol in the instrument panel will illuminate amber and notification messages will appear in the driver's display, also see page 59.

If the  symbol is illuminated, refuel at the next opportunity, (see page

171). Only use the remaining fuel for emergency use. Using this fuel may cause intermittent fuel starvation and potential engine damage. In such situations the driving style should be modified to minimise engine load and cornering forces.

Due to the remaining fuel within the fuel tank, the fill-up quantity could be less than the specified tank capacity shown within the 'Technical Data Section'.

 **CAUTION:** Do not allow the tank to run completely dry, as this could damage the catalytic converters and fuel pump. Any such consequence would not be covered by the New Vehicle Warranty.

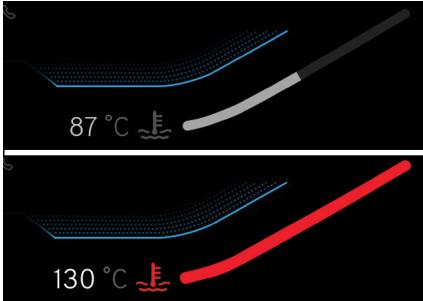

Engine Coolant Temperature Gauge

The length of the white zone increases as the coolant becomes warmer. The current coolant temperature is also shown next to the  temperature symbol.

If the coolant temperature becomes too hot, then the gauge line will become red in colour, the  symbol will also illuminate red and notification messages accompanied by a 1 second audible chime will also appear in the driver's display, also see page 61.

Ensure to follow the instructions on any engine coolant temperature notification messages that are displayed in the driver's display. These messages may include stopping the vehicle immediately and turning off the engine to prevent potential engine damage.

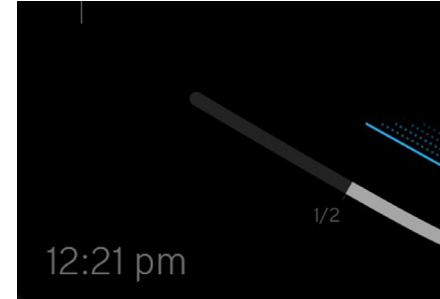

Clock

The clock is shown in both the driver and centre displays.

In the driver's display, the clock is located at the bottom right of the screen. See page 95 for available date and time setting options.

DISPLAYS, WARNINGS AND GAUGES

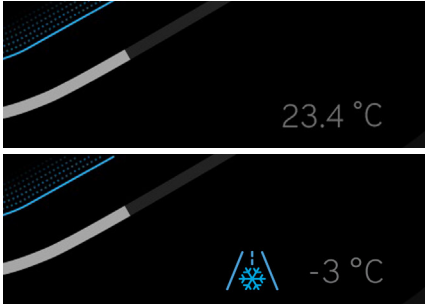

Outside Air Temperature

The outside air temperature reading is shown at the bottom right of the screen. See page 95 for available setting options.

The outside temperature reading displayed may be too high if the vehicle remains stationary.

A ❄️ snowflake symbol and warning message will appear accompanied with a 1 second audible chime if the outside temperature range is between -5°C to +2°C.

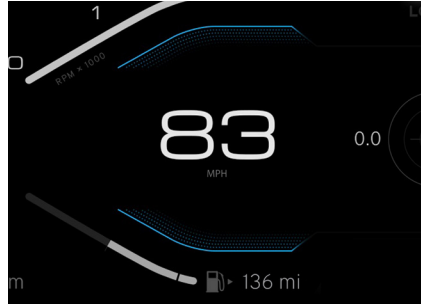

Speedometer

The display shows the vehicle road speed in either mph or km/h according to market.

The alternative speed value can be shown in the centre of the screen as a widget option, see page 72.

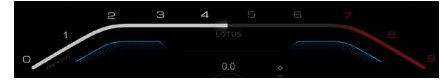

Tour Drive Mode

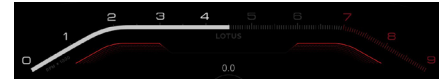

Sport Drive Mode



Track Drive Mode

Tachometer

Displays the engine speed in revolutions per minute, (rpm).

The tachometer layout displayed is specific to the vehicle drive mode selected.

The white zone within the gauge line represents the current engine speed. As engine speed increases the length of the white zone increases and the speed digit representing the rpm x 1000 is illuminated.

The LOTUS logo will begin to illuminate, becoming brighter as engine speed increases.

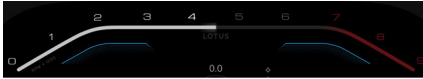

The 'red line zone' section of the tachometer represent the revolutions above the safe operating speed of the engine.

The maximum rpm display may vary dependant on the drive mode selected.

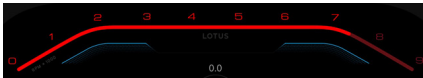

If the engine approaches or goes above the maximum safe engine speed, the gauge line and all speed digits will illuminate red.

Cold Engine Speed

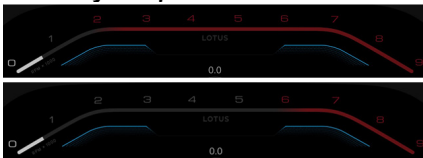

Maximum engine speed is graduated up to a maximum of 6,000 rpm during engine warm up until normal running temperature has been reached, the revised maximum rpm value display in

the red line zone during engine warm up is shown.

- ! **CAUTION:** The use of wide throttle openings and/or high rpm before normal running temperature has been reached should be avoided to reduce possible damage and wear.
- ! **CAUTION:** Do not run the engine continuously at its maximum speed. The engine is not protected from over speeding caused by inaccurate or premature gear down changing, which could cause engine failure not covered by the vehicle warranty.



Performance Gear Shift Lighting

This feature allows the driver to see the optimum upshift gear change points to ensure that the engine and transmission provide the maximum acceleration possible in every gear as well as warning the driver if the engine speed becomes too high.

- ! **NOTE:** For automatic transmission models, this option is only available with manual mode selected.

For information on the gear shift indicator for improved fuel economy, see page 67.

DISPLAYS, WARNINGS AND GAUGES

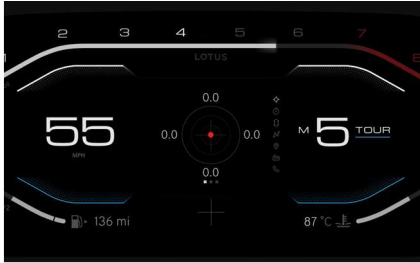

Upshift Indication Points

As engine speed increases and reaches the first shift level point, the upper drive mode indicator lines change to performance shift lighting, turning white in colour.

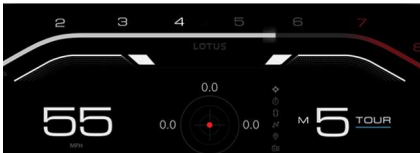

If engine speed continues to increase whilst remaining in the same gear, the second shift level will be reached, illuminating the outer shift blocks.

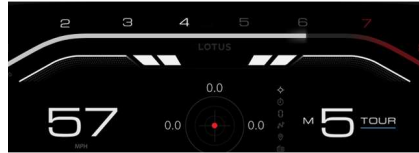

Continued increase in engine speed whilst remaining in the same gear will illuminate the third, inner level shift blocks.

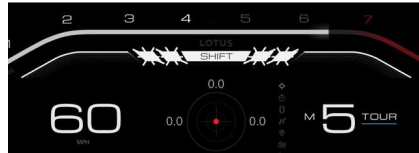

The performance shift lines and shift blocks will slowly flash and **SHIFT** will be displayed as engine speed continues to increase, indicating to the driver that the ideal shifting point has now been reached.

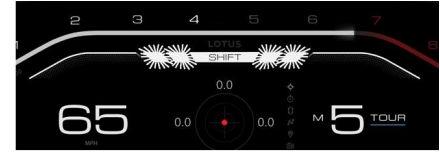

If the prompt to shift gear is ignored and the engine speed exceeds the final shift point, the performance shift lines and blocks will flash faster.

Gear Display

The gear indicator shows the current gear position selected.

Manual Transmission Models

Display available:

Neutral

Reverse

Gears 1 - 6



Automatic transmission models

Automatic mode display:

P - Park

R - Reverse

N - Neutral

D - Drive



Manual mode display:

Gears 1 - 6

'M' - Manual Mode will also be displayed.

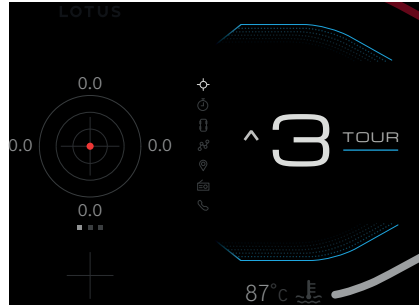

Gear Shift Indicator

An upshift arrow illuminates next to the current gear selected if the performance currently required can be achieved with improved fuel economy in a higher gear.

For automatic transmission vehicles this functions only when 'Manual Gear Selection Mode' is selected, see page 156.

Drive Mode Display

The format and layout of the driver's display is linked to current drive mode selected, also see page 57.

Tour

Performance gear shifting lighting is blue, tachometer, fuel level and engine coolant bar gauge displays are solid.



Sport

Performance gear shifting lighting is red, tachometer, fuel level and engine coolant gauge displays show incremental markings.

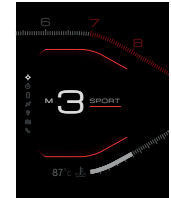

Track

Performance gear shifting lighting is yellow, certain driver information is repositioned on the screen, tachometer, fuel level and engine coolant gauge display formats are also changed.

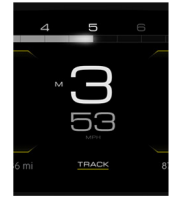

Also see page 58.

DISPLAYS, WARNINGS AND GAUGES

Lotus Launch Control

Only selectable if Lotus Launch Control is equipped on the vehicle. This feature is only available for automatic transmission model vehicles.

Lotus Launch Control can be activated in either 'Sport' or 'Track' mode. The most engine torque possible for this feature is available with the vehicle set in track mode to produce the fastest possible acceleration from a standing start.



WARNING: Under no circumstances should this feature be used on public roads.

Lotus Launch Control Preparation

To perform a Lotus controlled launch, the following vehicle conditions must be met:

- Vehicle must be stationary.
- Engine oil, coolant and transmission fluid are all in the normal operating temperature range.
- Steering wheel must be in the straight-ahead position.
- All tyres should be within their recommended inflation pressures
- There are no system faults present causing either the MIL (Malfunction Indicator Light) or stability symbol lamp illumination, see page 60 for further information.
- Current vehicle mileage is more than 805 km.



NOTE: Even if all other conditions are met, a Lotus Launch control cannot be performed until the vehicle mileage has exceeded 805 km.

Activating Lotus Launch Control

With the engine at idle speed:

1. Release the parking brake.
2. Select the 'Sport' or 'Track' mode.
3. Depress the brake pedal firmly with your left foot.
4. With the transmission in automatic mode, select D – Drive or select 'Manual Mode'.
5. With your left foot remaining on the brake pedal, fully depress the accelerator pedal with your right foot.
6. The engine speed will increase to its set limit.

A notification message is shown in the driver's display if not all of the launch control preparation conditions are met.

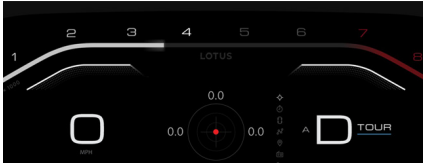

If all of the preparation and activation conditions are met, the upper drive mode indicator lines change to white in colour, converting almost instantaneously into a launch timer.

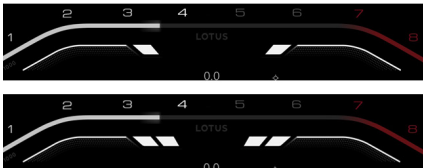

The launch timer continues counting down.

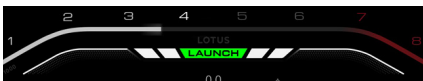

Once launch mode is ready **LAUNCH** is displayed.

Release the brake pedal with your left foot whilst continuing to keep the accelerator pedal firmly depressed. The vehicle will perform a launch start, providing maximum acceleration.

Further controlled launches can be performed after the engine oil, coolant and transmission fluid return to their normal operating temperature range.

Deactivating Lotus Launch Control Whilst Accelerating

Release the accelerator pedal or apply the brake pedal.

Whilst Stationary

Release the accelerator pedal or wait for approximately 5-10 seconds until launch control is deactivated. The message 'Launch Mode aborted' will be shown on the Driver Display.

Or



If one or more of the launch control parameters as shown on page 68 are no longer met.





DRIVER DISPLAY WIDGETS

Widget Options



Widgets shown in the driver's display are controlled using the right-hand steering wheel keypad switches. They can also be viewed in the central display screen, see page 103.



⚠ WARNING: Do not become distracted by these system options whilst driving. You could cause an accident.

Press the  up/down buttons on the right-hand keypad to view or select the infotainment widget options in the driver's display. Use the  button in left-hand keypad to start voice call functions.



View any displays available for a widget option by pressing  left/right buttons or  swipe the  button. Press the  button to select an option.









Press  to access any available menu setting options.

If no other function is active,   buttons are used for volume control.

-  **Performance**
g-Force meter.
 Performance gauges.
Downforce gauge.
Track widget.



-  **Phone**
Access recent calls.
 Access favourite contacts.
Voice call.

-  **Lap Timer**
Recording a lap time.
 Recording best lap time.
Saving a session.
-  **Trip Computer**
Trip computer A or B.
Odometer.
 Instantaneous fuel consumption.
Average fuel consumption.
Average or alternative speed.
-  **Vehicle Health**
Tyre pressures.
 Service due date.
Notifications.
-  **Media**
Radio.
 Bluetooth.
Device projection.
USB.

DRIVER DISPLAY WIDGETS

See pages 71 and 73 for information on right-hand steering wheel keypad operation and application resetting procedures.

See page 103 for information on centre display option settings.



Trip Computer

Odometer Screen

This screen displays:

Odometer

Displays the total distance the vehicle has travelled; this cannot be reset.

Trip A

Displays the distance the vehicle has travelled since trip A was last manually reset.

Trip B

This can be set to display the distance the vehicle has travelled during one drive cycle or since the fuel tank was last refuelled.

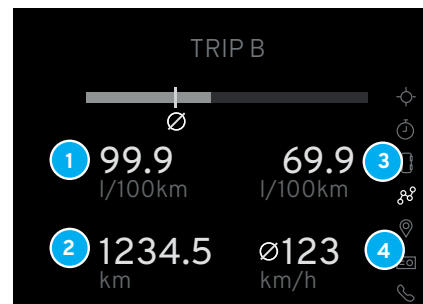

Trip A & B Screens

These screens display:

- 1 Instantaneous fuel consumption.
- 2 Trip A Screen:
Distance travelled since trip was last manually reset.
- 2 Trip B Screen:
Distance travelled during current drive cycle or last fuel tank refuel.
- 3 Average fuel consumption since trip was last reset.
- 4 Average or alternative speed,



Performance

View the widget menu screens using the steering wheel right-hand keypad controls as shown on page 71.

g-Force Meter

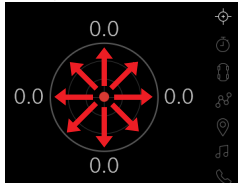

The current directional g-force experienced by the vehicle is indicated by the red dot as it moves across the area within the circles, which represent the different levels of g-force.

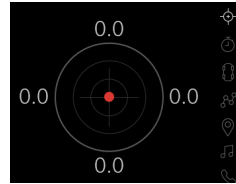

Pressing displays the maximum g-force values (measured as g), attained during the current drive cycle.

- A - Acceleration.
- B - Braking.
- L - Left.
- R - Right.

Performance Gauges

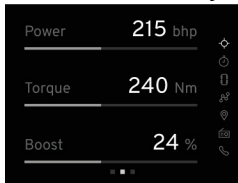

Press or to display current engine performance data.

Power in BHP.

Torque in Nm.

Boost for supercharger.

Downforce Gauge



Press or to display the current downforce. The number of illuminated airstream lines above the vehicle increase as downforce increases.

Track Widget



This menu is available if the vehicle is equipped with the track mode option.

Press or to display the track widget.

Press or then press to select an option.

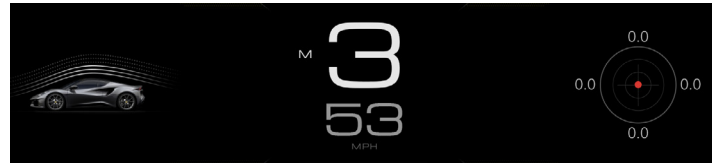

With the driver's display in track mode, the track widget selected is shown on the left of the screen and the other menu option selected is shown on the right.

DRIVER DISPLAY WIDGETS



Manual Lap Timer

View the widget menu screens using the steering wheel right-hand keypad controls as shown on page 71.

Starting a Session

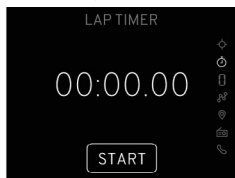

Pressing **O** starts a new session.



The current lap number is displayed above the activated timer.

Recording a Lap Time



With the LAP button highlighted, pressing **O** again stops the timer and records the lap time. If this is the first lap, then it will be recorded as the current best lap time.

Starting a New Lap



With the LAP button highlighted, Press **O** again to start a new lap and again to stop the timer.



If a best lap time is available when a new lap is registered, then the time difference between the previous lap time and the current best lap time for the session is displayed for 10 seconds.



If the current lap time is slower than the best lap registered lap time, the time difference will be shown in red.

If a quicker lap time is achieved, the time difference will be shown in green.

Stopping a Lap



The timer can be stopped during a lap and reset to zero.

Press to highlight the STOP button.

Press to stop the timer.



The timer for that lap is reset to zero and the STOP button is replaced by a START button.

With START highlighted, press to restart the timer for that lap.

Ending a Session



Press to highlight the STOP button as shown above.

Swipe again to highlight the END button.

Press to end the session.

Saving a Session

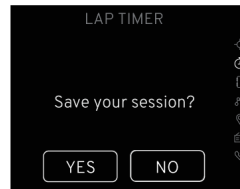

A message asking if the session should be saved is displayed.

Press to highlight YES or NO then press to select.



If YES is selected, a message confirming the session has been saved is displayed.

If NO is selected, a prompt is displayed.

A notification will also be shown in the centre display screen when a session is saved.

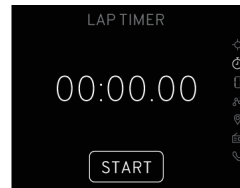

The lap timer start menu is displayed.

Press to start a new session.

Press or to view another menu option.

DRIVER DISPLAY WIDGETS



Resetting Trip Computer

View the menu widget screens using the steering wheel right-hand keypad controls as shown on page 71.

Trip A

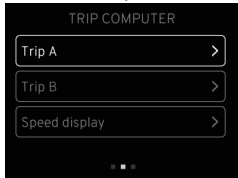

From the trip menu, press $\langle \rangle$ or \leftarrow to display trip computer.

Then press \diamond or \leftarrow to highlight Trip A and press \circ to select.

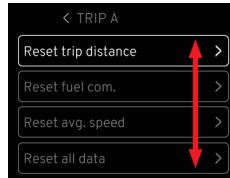

Press \diamond or \leftarrow to highlight reset option and press \circ to select.

Note: All options for trip A can also be reset by pressing the reset button on the end of the the light switch, see page 113.

Trip B

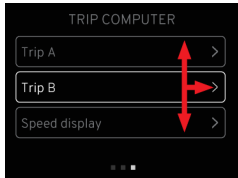

From trip computer menu press \diamond or \leftarrow to highlight Trip B and press \circ to select.



Press \diamond or \leftarrow to highlight reset option and press \circ to select.

Speed Display

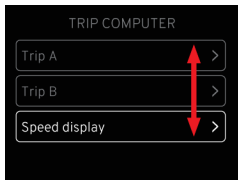

From trip computer menu press \diamond or \leftarrow to highlight Speed display and press \circ to select.

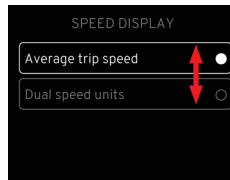

Press \diamond or \leftarrow to highlight speed option and press \circ to select.



Vehicle Health

View the menu screens using the steering wheel right-hand keypad controls as shown on page 71.

Tyre Pressures



Service Due Status



Notifications



Press to access

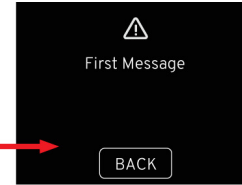

Press or to view messages.



Tyre pressure monitoring system, see page 201.

Service due date, see page 183.

Notifications, see page 61.

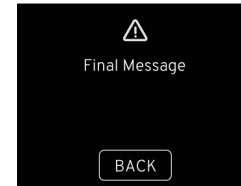

Press to exit

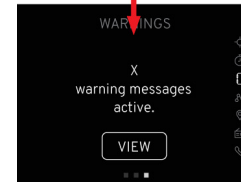

DRIVER DISPLAY WIDGETS



Media

View the widget menu screens using the steering wheel right-hand keypad controls as shown on page 71. Also refer to the separate infotainment booklet for further information. From the media menu you can select:

Radio

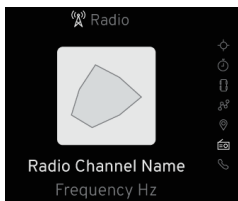

Select stations from the AM/FM/DAB radio.

The station name, song title and artist will be shown if available.

Bluetooth

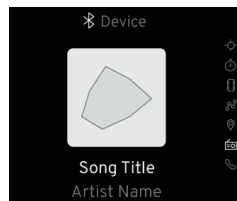

Media can be played from a suitable device connected by Bluetooth.

The album cover, song title and artist name will be shown if available.

Apple CarPlay

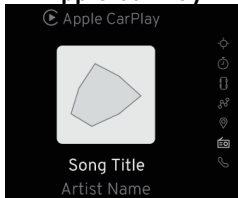

Android Auto

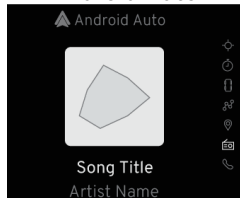

You can use the apps available on Apple CarPlay or Android Auto using a suitable device once it is either paired or connected via the USB connector to the infotainment system.

The information shown on the driver's display will vary dependent on the app selected.

USB

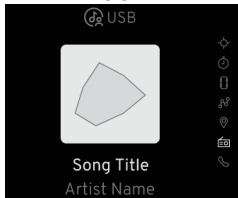

The infotainment system will play any recognised audio files stored within a connected USB storage device (flash drive/memory stick).

The album cover, song title and artist name will be shown if available.

NOTE: MP3 players (including iPod) will not play on the infotainment system.



Phone

View the widget menu screens using the steering wheel right and left-hand keypad controls as shown on page 71. Also refer to the separate infotainment booklet for further information. With a compatible phone paired to the infotainment system, from the phone menu you can select:

Access Recent Calls

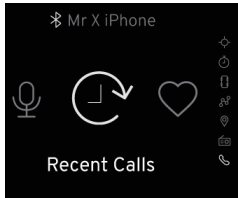

Press < or > or to display recent calls.
Press to enter menu.

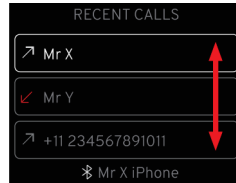

Press or to view contact details of recent calls.
Press over highlighted recent call contact to dial.

Access Favourite Contacts

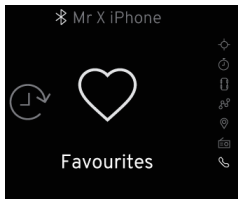

Press < or > or to display favourite contacts.
Press to enter menu.

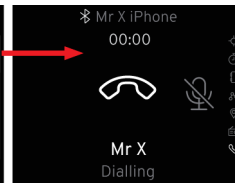
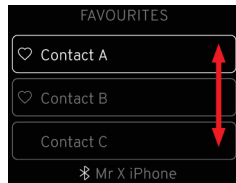

Press or to view contact details.
Press over highlighted contact to dial.

Voice Call (If Available)

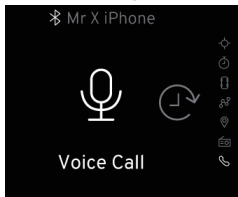

Press < or > or to display voice call.
Press to enter menu.
Press the button on the left-hand steering wheel keypad.

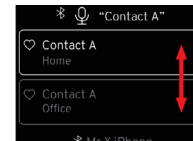
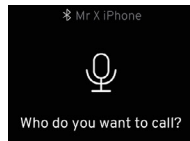

When the audio system mutes, say the name of the contact you wish to call.

Any stored contacts recognised by that name will be shown.
Press or to view contact details.
Press over highlighted contact to dial their number.

DRIVER ASSISTANCE

Cruise Control

Cruise control helps to maintain an even road speed without using the accelerator pedal, which can benefit the driver when driving on motorways or long, straight roads in regular traffic flows.

⚠ WARNING: Use only when road and traffic conditions allow.

Driver assistance systems such as cruise control are developed to support the driver and not to replace the driver's attention.

The driver accepts full responsibility when driving the vehicle.

The driver should be prepared to take over control of vehicle speed to avoid hazardous or poor road surface conditions & maintain distance from preceding traffic.

Cruise control can be selected above speeds of 32 km/h.

Vehicle speed can be set in 1 km/h increments. Cruise control cannot be used if track mode is selected.

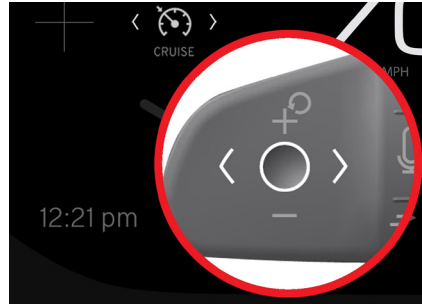

Standby Mode

Cruise control is operated using the switches on left-hand side steering wheel keypad.

Press <> or O to display the cruise control symbol in the driver's display.

If the symbol is white then cruise control is in standby mode.

If the symbol is grey, then cruise control cannot be activated.

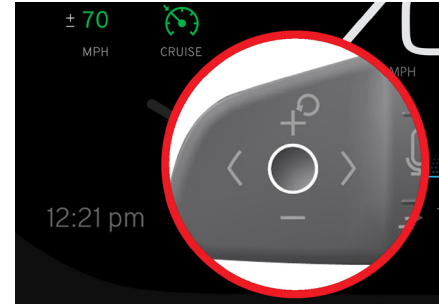

Activation

With cruise control in standby mode:

- Accelerate/decelerate to the required vehicle road speed.
- Press the button.
- The current vehicle road speed is set.
- The set speed is displayed next to the symbol which is now illuminated green, cruise control is now active.
- The accelerator pedal can now be released and set vehicle road speed will be maintained.

DRIVER ASSISTANCE

Notification Messages

A message is shown in the driver's display if cruise control is not unavailable or has been cancelled, see page 61.

Increasing Vehicle Speed

Vehicle road speed can be temporarily increased using the accelerator pedal, when the accelerator pedal is released, the previously set vehicle road speed is resumed.

Increasing Cruising Speed

With cruise control active:

Press and hold down the  button or press repeatedly, the vehicle road speed will increase continuously or in 1 km/h increments.



Or

Accelerate to required speed and press the  button.





Decreasing Cruising Speed

With cruise control active:

Press and hold down the  button or press repeatedly, vehicle road speed will decrease continuously or in 1 km/h increments.



Manual Deactivation

Press the  button. The  symbol and set speed will illuminate white again in the driver's display. Cruise control has now returned to standby mode and the last set vehicle road speed is stored for reuse if required.





Automatic Deactivation

- Vehicle road speed decreases below 32 km/h.
- Vehicle road speed increases above 210 km/h approximately.
- Pressing the brake pedal.
- Traction Control or Electronic Stability Control is activated.
- Track mode is selected.
- The vehicle speed is higher than the set speed for longer than 1 minute.

The  symbol and set speed will illuminate white again in the driver's display. Cruise control returns to standby mode and the last set vehicle road speed is stored for reuse if required.

Resuming Cruise Control

With cruise control deactivated (but not turned off):



Press the  button to reactivate. The cruise control set speed and  symbol in the driver display will change colour from white to green and the vehicle road speed will return to the previously stored set speed.





 **WARNING:** Only resume cruise control if you want to return to, and are aware of, the set speed.

To Turn Off

From Standby Mode:

Press  or  button to display another option.

When Active:

- Press the  button to set cruise control to standby mode.
- Then press  or  on the left-hand steering wheel keypad to display another option.

The  symbol will extinguish and the set speed is deleted.

Cruise control will remain active if changing between driving modes but cancels whenever the engine is turned off.

Speed Limiter

The speed limiter prevents the vehicle exceeding a preset maximum speed.

 **WARNING:** Use only when road and traffic conditions allow.

Driver assistance systems such as speed limiter are developed to support the driver and not to replace the driver's attention.

The driver accepts full responsibility when driving the vehicle.

The driver should be prepared to take over control of vehicle speed to avoid hazardous or poor road surface conditions & maintain distance from preceding traffic.

The speed limiter can be activated from 32 km/h.



Vehicle speed can be set in 1 km/h increments.

Deviations from the limited speed may occur when driving downhill.

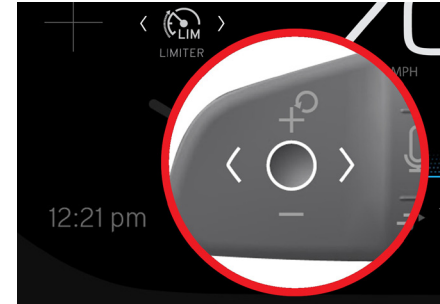
The speed limiter cannot be used if track mode is selected.



Standby Mode

Press  or  on the left-hand steering wheel keypad to display the  speed limiter symbol in the driver's display.

If the  symbol is white then speed limiter is in standby mode.

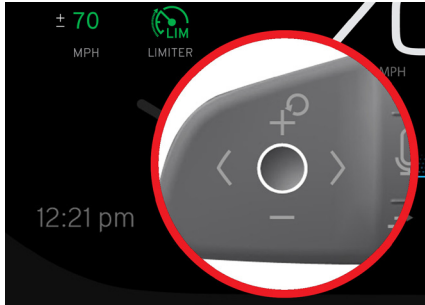

If the  symbol is grey, then the speed limiter cannot be activated.

DRIVER ASSISTANCE





Activation

With speed limiter in standby mode:



- Press the  button.
- The maximum vehicle road speed is set and stored.
- The maximum vehicle road speed is displayed next to the  symbol which is now illuminated green, the speed limiter is now active.
- The vehicle will now only accelerate up to that preset speed.

Adjusting Maximum Speed

With speed limiter active:
Press and hold down either the  or  buttons or press repeatedly to increase or decrease the maximum speed.



The maximum vehicle road speed will increase or decrease continuously in 0.6 mph (1 km/h) increments.

Deactivation

Press the  button. The  symbol and set speed will illuminate white in the driver's display. The speed limiter is now in standby mode.

Resuming

With speed limiter deactivated (but not turned off):



Press the  button to reactivate. The speed limiter set speed and  symbol in the driver display will change colour from white to green.

The vehicle will now only accelerate up to the preset stored speed.







To Turn Off

From Standby Mode:

Press  or  button to display another option.

When Active

- Press the  button to set speed limiter to standby mode.
- Then press  or  on the left-hand steering wheel keypad to display another option.

The  symbol will extinguish and the maximum set speed is deleted.

Speed limiter will remain active if changing between driving modes but cancels whenever the engine is turned off.

Temporary Deactivation of Speed Limiter

During overtaking, the vehicle speed might have to be higher than the set speed limit. To temporarily deactivate:

- Fully press the accelerator pedal until the speed limiter is temporarily deactivated.
- You can then overtake the other vehicle.
- Fully release the accelerator pedal when the temporary acceleration is finished.

Engine braking will then automatically restore the vehicle speed to below the last stored maximum speed.

Speed Limiter Limitations

On steep downhill gradients the speed limiter's braking effect may be inadequate and the actual vehicle road speed may exceed the stored maximum speed.

DRIVER ASSISTANCE

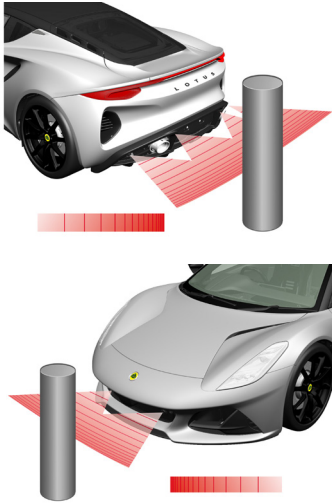

Park Assist System

The Park Assist System (PAS)* uses ultrasonic sensors to indicate if there are any objects close to the front and rear of the vehicle when parking or manoeuvring.

The PAS automatically activates when reverse gear is selected, operating at any speed in reverse and when driving forward at low speed up to 12 Km/h.

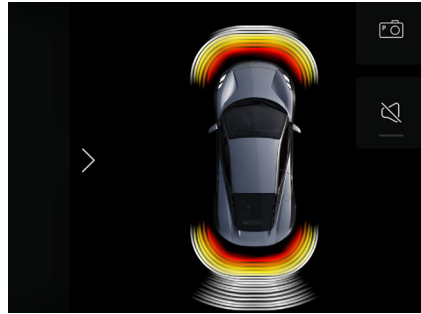

When active, an image of the vehicle is shown in the centre display, sensor fields indicate any objects that are detected and their proximity relative to the vehicle.

An audio feedback signal will sound, increasing in frequency if any objects are detected within the path of the vehicle. The active sensor field closest to the vehicle image changes colour from white – yellow – amber and then red as the object becomes closer.

All other audio feedback from the infotainment system will reduce in order to prioritise the warning for the PAS.

Tap the button on the display to turn the sound on or off as required.

Unless the rear PAS detects an object within the red zone, The audio feedback will turn off once the vehicle has remained stationary for 2 seconds.

PAS is active during start/stop driving, but will deactivate if the parking brake is applied, or for automatic vehicles, P – Park is selected.

*PAS is an optional feature and may not be fitted to your vehicle.

⚠ WARNING: These features are only aids to parking and are not a substitute for vigilant all-around observation. The driver is responsible for safe manoeuvring and driving safely at all times.

⚠ WARNING: Take time to familiarise yourself with the PAS audio feedback and the actual distance being detected before fully utilising this system.

 **WARNING:** The PAS may not detect small or moving objects including children and animals, low or narrow posts, towing hitches, kerbstones and objects towards either side of the vehicle.

 **WARNING:** To ensure full functionality, the PAS sensors must be kept clean and free from foreign objects including snow and ice.

 **CAUTION:** The PAS sensors cannot detect high objects. Ensure to use extra vigilance when manoeuvring the vehicle where protruding objects such as loading docks, shelves and hangers etc could be near the vehicle.

See page 18 for PAS sensor locations.

Washing Park Assist System Sensors

See page 227.

Park Assist System Presets

The Park Assist System can be activated/deactivated or the volume level set from the centre display screen. See page 95 and 97 for further information.

DRIVER ASSISTANCE



Parking Assist Camera

Viewed from the centre display, the Parking Assist Camera (PAC) shows a view of the area behind the vehicle.



The PAC will automatically activate at any speed when reverse gear is selected, or manually using the centre display screen.

Trajectory guidelines are overlaid on the camera image to represent ground level behind the vehicle. The lines represent the rearward trajectory of

the vehicle. The lines will adjust relative to the rotation of the steering wheel.

See page 18 for rear parking camera location.

The PAC works in conjunction with the Park Assist System (PAS) and can both be viewed at the same time.

⚠ WARNING: These features are only aids to parking and are not a substitute for vigilant all-round observation. The driver is responsible for safe manoeuvring and driving safely at all times.

Parking Assist and Camera Options
Options are shown to the side of the screen when the PAC is active.

P) Turn on/off the PAS, see page 95.

 Turn on/off the PAC trajectory guidelines.

 Turn on/off PAS sensor fields.

 Mute/unmute PAS sensor audio feedback.

Blind Spots

The camera has limited field of view. If a child or object in your rear parking camera view suddenly disappears then the area behind the vehicle should be rechecked before continuing to reverse as they may have entered the camera's blind spot.

⚠ WARNING: The PAC may not detect small or moving objects including children, animals, low or narrow posts, towing hitches and objects towards either side of the vehicle.

Ambient Lighting

Although the camera image adjusts automatically to the ambient light conditions, ambient lighting that is either too dark or bright may reduce the quality of the image shown in the centre display.

Owner Maintenance

To ensure full functionality, the PAC lens must be kept clean and free from foreign objects including dirt, snow and ice.

Washing Park Assist Camera Lens

See page 227.

CENTRE DISPLAY SCREEN

Centre Display Overview

Infotainment, certain vehicle controls/widgets/application options and menus as well as personalised settings are accessed from the centre display. Some buttons on the display will change appearance and function dependent on the application or menu screen currently shown.

WARNING: Do not become distracted by the centre screen display whilst driving. You could cause an accident. It is recommended to stop the vehicle before using certain applications available, such as using the keyboard, entering address and contact information etc.

NOTE: Some functions will be disabled once the vehicle is moving.

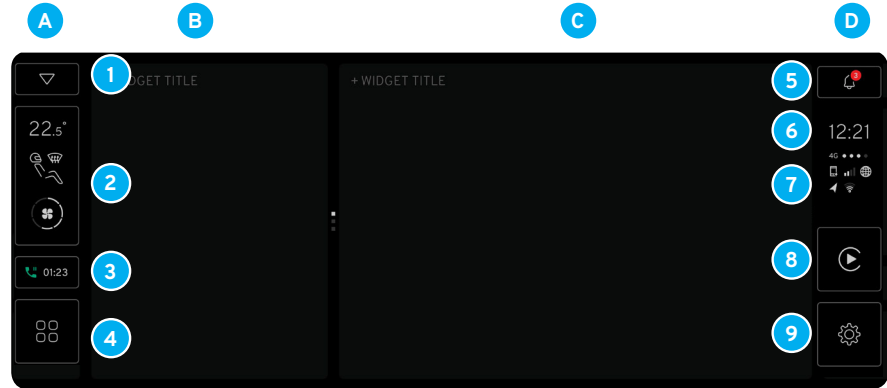

B Small Widget Display

A Navigation Bar

- 1 Quick panel.
- 2 Climate Control.
- 3 Duration of phone call.
- 4 App launcher/home.

C Large Widget Display

Notification centre.

Clock.

Device status*

Device projection.

Global settings/app options.

D Side Bar

- 5
- 6
- 7
- 8
- 9

*Refer to separate infotainment guide.

CENTRE DISPLAY SCREEN

Display Navigation

Tapping an option on either the side, or navigation bar may direct you straight to that option, or instead, show any applicable menu pages.

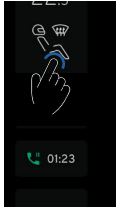

Tap the < back button within a sub-menu option screen to return to a previous menu screen.



The home  button becomes available on the navigation bar when an application or the app launcher is open. Tap to return to the home screen display.

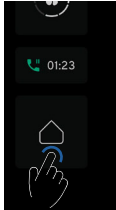

Display Operation

The display and menu options are finger activated and will respond based on the finger movement used.

Action



Tap once.



Tap twice quickly.



Press and hold.



Panning – Drag from one part of the screen to another part of the screen.



Flick - Move a finger from one point to another quickly, then remove.



Drag and drop.



Pinch - Move fingers together, then remove.



Spread - Spread out fingers, then remove.

Result

Highlight an object/confirm selection/activate a function.

Zooms in and out of an object.

Grab an object/move apps/map points on the map.

Scroll a map or move an item.

Scroll quickly or remove a page.

Move an item.

Zoom out.

Zoom in.

Automatic Activation/Deactivation

The display automatically activates/deactivates when the driver's door is opened/closed. The display may also turn off automatically to prevent battery drain.

Manual Deactivation

If required the widget display area can be turned off by pressing and holding down the volume button in the centre console for 5 seconds, leaving only limited options in the side and navigation bars illuminated. Another short press of the volume button will turn on the widget display.

Illumination

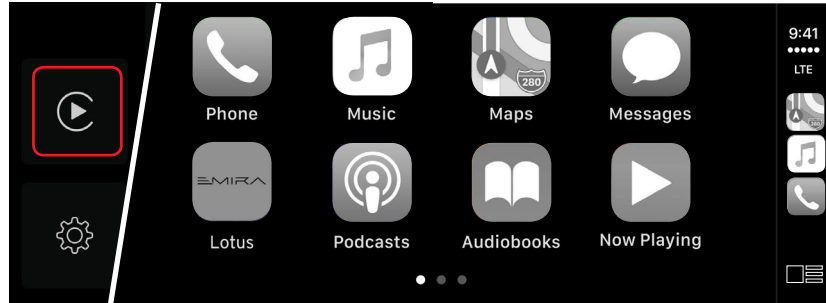

The display illumination level automatically decrease when the light sensor in the dashboard detects a sufficient reduction in the ambient brightness level. When this occurs the illumination level can be manually adjusted using the illumination control wheel, see page 117.

**Device Projection**

A projection symbol is displayed if a mobile device is connected to the infotainment system with either Apple CarPlay or Android Auto apps available.

No projection symbol will be displayed if this feature is not available on a connected device.

Opening Device Projection Screen

 If available, tap either the  or  button displayed on the side bar to view the mobile apps available.

For further information, refer to the separate infotainment supplement as well as any instructions available for your device.

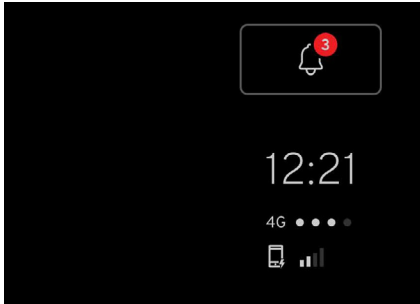

CENTRE DISPLAY SCREEN



Notification Centre

Pop-up messages for missed calls or system notifications previously shown and ignored in the driver and centre display can be viewed again in the notification centre.

Opening the Notification Centre

 Tap the  button.

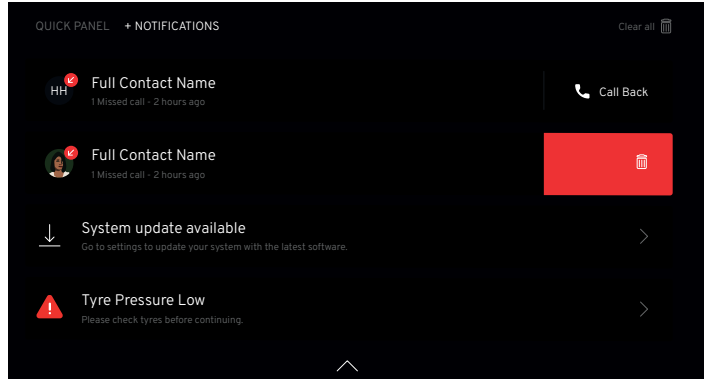

Messages



Scroll to view all of the messages.





For phone messages, tap the  symbol to call back.



Clear all messages by tapping the  button at the top of the screen.



 Clear individual messages by sliding the message to the left of the screen to reveal the  button and tap, or slide the message to the end of the screen.

Closing the Notification Centre



Swipe up anywhere outside of the message list.





Tap the  symbol at the bottom of the screen.

Global Settings and App Options

The operation of certain vehicle functions can be set or adjusted.



Opening the Global Settings and App Options

 Tap the  button from the home screen, to activate the settings sidebar.

Setting Menu Options

Car: General, Climate, Exterior lights, Driver support, Security and Mirror settings.

Connect: Device connection, Bluetooth, Wi-fi, mobile data and vehicle name, see separate infotainment supplement for further information.

System: Languages for display screens and keyboard, unit values, clock/date formats, voice command options.

Audio: Volume adjustment, sound optimisation, equaliser settings, vehicle speed compensation and ringtone settings, see separate infotainment section for further information.

CENTRE DISPLAY SCREEN

Setting	Menu	Options
General >	Electric parking brake:	Automatic activation/deactivation.
	Windscreen wipers:	Set to service position.
	Car information:	RMS activation indication and V.I.N. information.
	Reset car options:	Reset vehicle settings to factory default.
Climate >	Recirculation timer:	Automatic cancellation after 30 minutes.
	Fan Intensity auto mode:	Low, medium and high intensity level options.
	Auto rear defrost:	Heated rear screen automatically activates below temperatures of 7°C.
	Auto start seat heating:	Set the duration period of automatic seat heating.
Mirror Settings >	Auto dim level:	Select between “light”, “normal” and “dark”.
	Exterior mirror tilting:	Tilt door mirror glasses when reverse gear selected.
	Visible unlocking feedback:	Activate/deactivate direction indicator lamp feedback.
	Fold mirrors when locking:	Activate/deactivate the folding mirrors.
Driver Support >	Park assist system:	Activate/deactivate/set volume level.
Security >	Visible locking/unlocking feedback:	Activate/deactivate turn indicators when locking or unlocking the vehicle.
	Auto-lock doors while driving:	Activate/deactivate the auto-lock door function.
	Reduce alarm level:	Deactivate tilts and interior sensors.
Exterior Lights >	Triple flash sequence:	Direction indicators flash 3 times.
	Welcome lights:	See approach lighting.
	Home safety lights:	Set timer period.

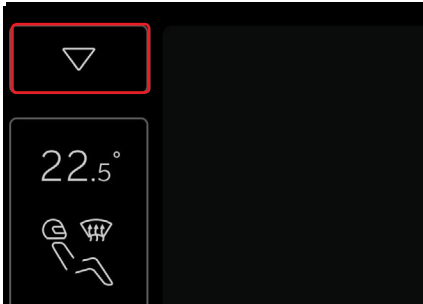

Quick Panel

The quick panel provides shortcuts to certain vehicle option presets and settings.

Opening the Quick Panel

Access the quick panel from the home screen either by:

-  Tapping the ▾ quick button at the top of the navigation bar.

The notifications option is also available from the quick panel.

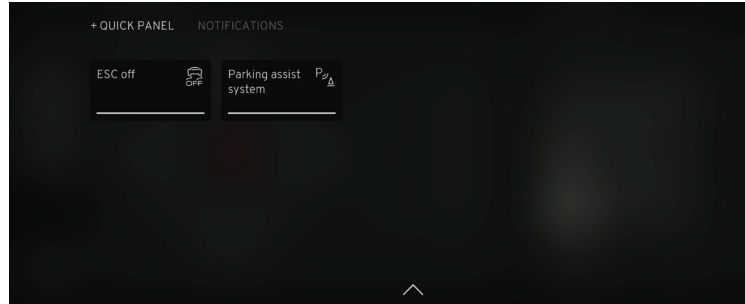



Quick Panel Options





ESC 'Off'.
Parking Assist System.

 **NOTE:** Other options may be available dependent on vehicle specification or market.

Selecting Options

-  Tap the required button. A message describing the application option selected or further actions required is displayed.
-  If preset levels are available, tap on the button to select the level required.
-  Tap on the button to deselect the option.

Closing the Quick Panel

-  Swipe up anywhere on the screen.
-  Tap the handle icon at the bottom of the screen, an animation is displayed showing that the screen needs to be swiped upwards to close.
-  Access the notification centre by swiping from right to left anywhere on the screen.
-  Tap 'Notification' to open the notification screen.

CENTRE DISPLAY SCREEN

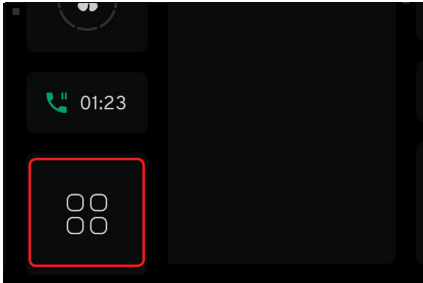



App Launcher

Access to some of the menu options and settings viewed from the driver's display and controlled by the right-hand steering wheel keypad can also be accessed using the app launcher button.



From the home screen display, the home button is replaced by the app launcher button.

Opening the App Launcher

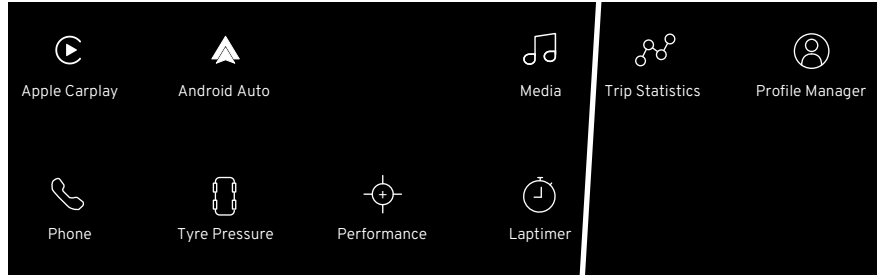
 Tap the  app button at the bottom of the navigation bar.



Selecting Applications

-  Scroll across the screen to view all available apps.
-  Tap the required button.
-  Tap and hold an app to move it on the screen to reorganise the app positioning as desired.

Options



- Apple Carplay*
- Android Auto
- Media
- Phone
- Tyre pressure
- Performance
- Lap timer
- Trip statistics
- Profile manager



*With suitable device connected.

System Settings

The operation of certain vehicle settings can be adjusted from this screen.

Opening the System Options

 From the home screen, tap the  button to activate the settings application.

 From the settings side bar tap the  button to display system setting options.

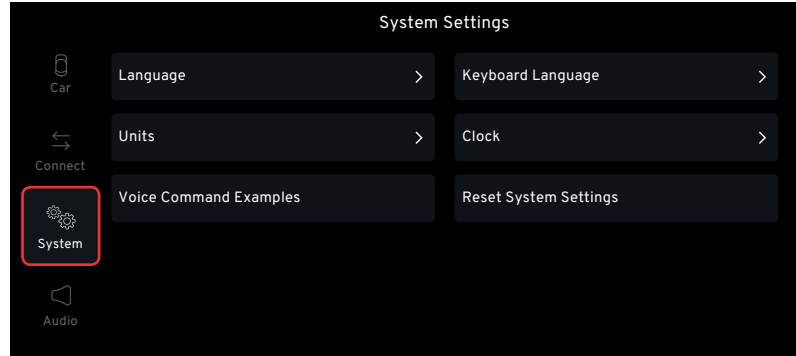

System Setting Options

Language	Select from 12 languages for the driver's and central display screens.	Keyboard Language	Select from 12 languages for the keyboard functions.
Units	Select alternative units for fuel consumption, ambient temperature and odometer distance.	Clock	Change the date and time formats and manually set the date and time.
Voice Commands	Select vehicle functions such as media, climate control and Bluetooth connected phone can be voice activated.	Reset System Settings	Select specific system settings to return back to factory default settings.

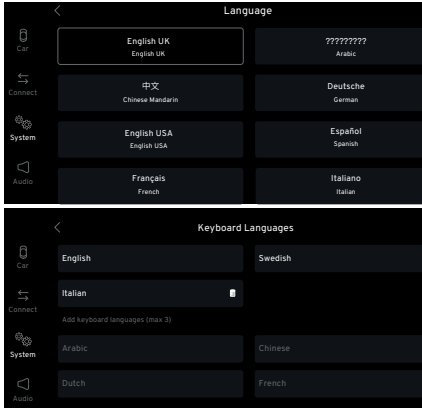

CENTRE DISPLAY SCREEN



Language Settings

You can change the language for the driver's, central display screens and keyboard.

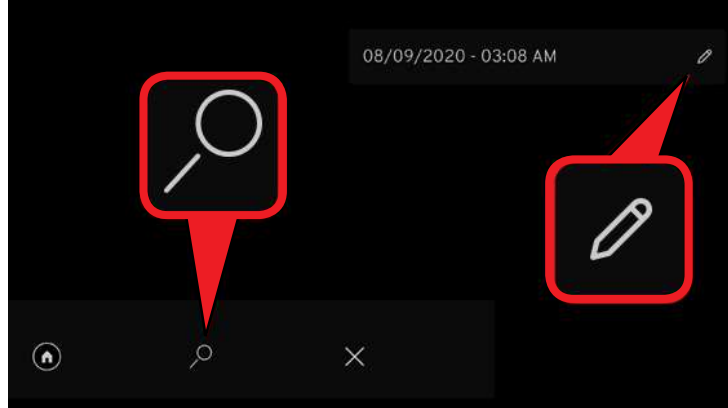

 Tap the languages option from the system settings screen. The language option currently selected is shown in the top left side of the screen.

  To change the language, scroll through the screen if necessary and tap the required language option.



Keyboard

The keyboard is used to write text, enter passwords or other information stored in the infotainment system and vehicle.

The keyboard can only be activated when either the  search or  edit icons are displayed.

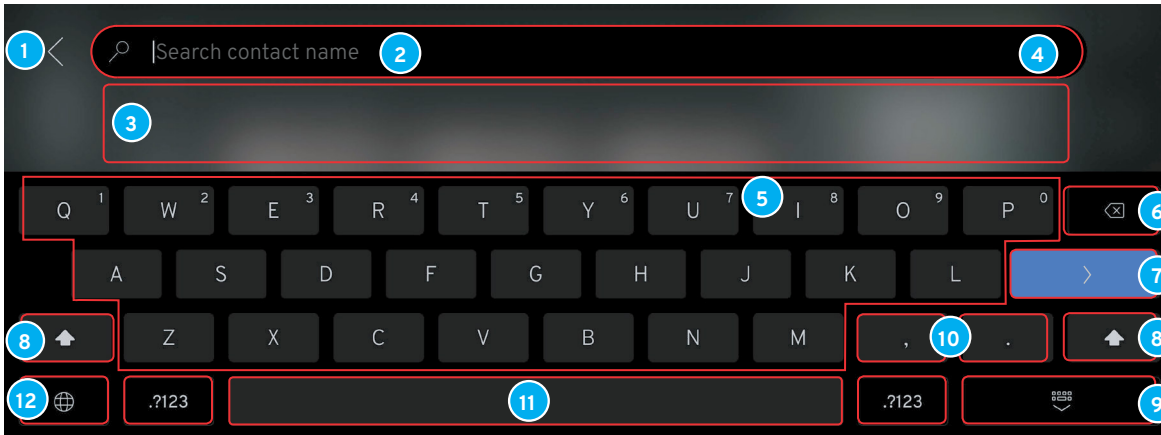

Keyboard Functions

- | | |
|---|--|
| 1 Cancel - return to previous screen. | 7 Return. |
| 2 Input field where characters entered are displayed. | 8 Shift/cap lock, (double tap for capital letter lock). |
| 3 Search results display, (tap a result to select). | 9 Hide keyboard. |
| 4 Delete all input at the same time. | 10 Press and hold for special symbols such as @ or .com. |
| 5 Keyboard characters. | 11 Space bar. |
| 6 Backspace, hold to erase several characters. | 12 Language selector. |

This is an overview of the keyboard. The keys shown and their appearance may change depending on the language selected or in the method the keyboard is used.

CENTRE DISPLAY SCREEN

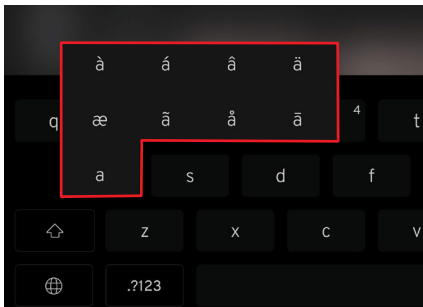
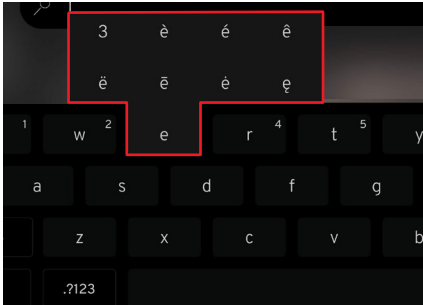

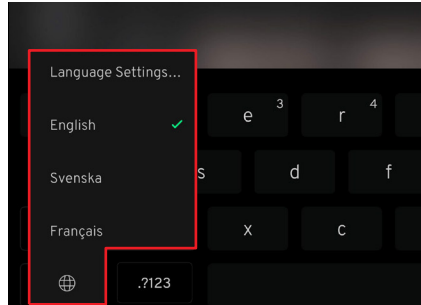

Key Pop-ups

 Tap and hold certain keys to display pop-ups showing additional functions or keyboard characters that can be selected. Tap anywhere outside of a key pop-up to close.



Keyboard Languages

  Tap and hold the  button to activate the language pop-up. You can select from 3 available languages or by tapping 'Language Settings' be directed to the language option with system settings.

CENTRE DISPLAY SCREEN



Widgets

Dependent on the option selected, a large and small widget are shown on the viewing area of the display screen.

 From the home screen display flick the widgets on the screen to scroll up or down to view the available options.

CENTRE DISPLAY SCREEN

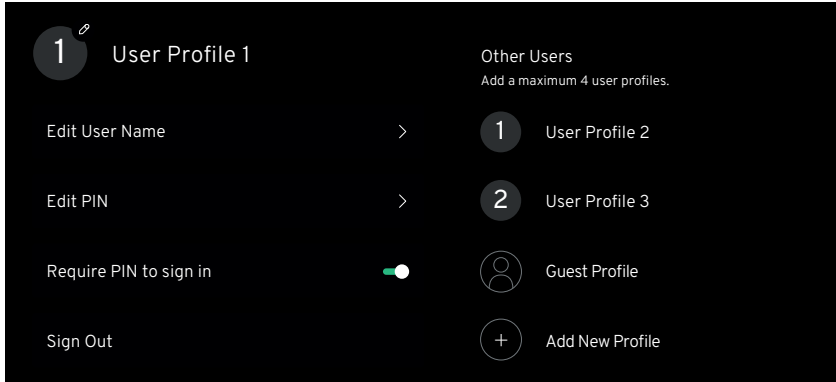

Driver Profiles

Many of the settings that can be made in the central display can be saved as preferences within the driver profile menu.

Many of the settings made are automatically saved if a driver profile is active.

Up to 4 'Personal' profiles can be created, in addition to the 'Guest' profile.

Profile Setting Types

Personal These are settings that can be saved in any active driver profile and include functions such as audio/media system, language and voice control.

Global These are settings that can be changed but are not then saved to a specific driver profile. If a global setting is changed, it will change that specific setting across all driver profiles.

Keyboard layout settings are global. If a driver profile adds an additional language to the keyboard, they are also available when a different driver profile is used.

Guest This is a local profile and if used will store local settings made and will use these settings the next time the 'Guest' profile is selected.

If the driver profile last selected is not PIN protected, then that profile will be active the next time the vehicle is unlocked. If the last selected profile was PIN protected, then the 'Guest' profile will be automatically selected when the vehicle is unlocked.

Default Profile for a New Vehicle

The 'Guest' profile is automatically selected as no other profile is linked to a new vehicle.

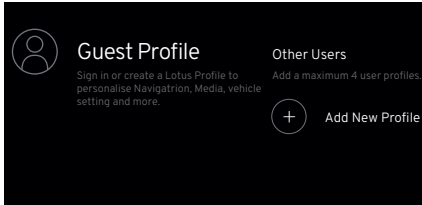

Adding a New Profile

- Tap the ☰ app button at the bottom of the navigation bar, see page 98.
- Tap Profile Manager option.
- Tap Add New Profile.

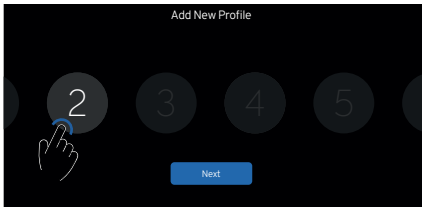

- Tap to select a profile, then tap Next.

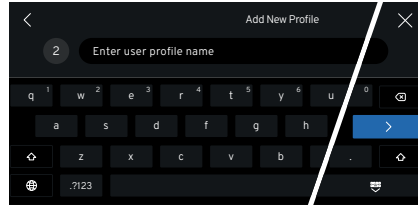

- Enter name using keyboard, then tap the return key.

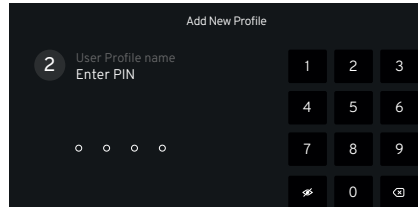

- Following screen instructions, enter and confirm a 4-digit PIN code of your choice using the keypad.

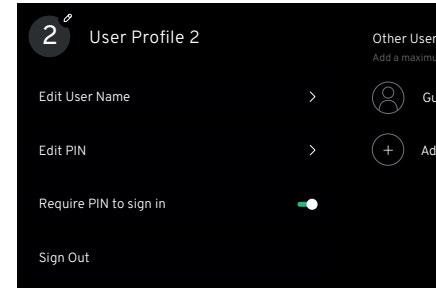

The profile edit screen will appear once the pin is confirmed.

- Tap to edit your username and PIN code if required.
- Tap to select if PIN code is required to sign into the profile.
- Tap 'Sign Out' to return to profile selection menu.
- Or tap the home button on the navigation bar to return to the central display home screen.

CENTRE DISPLAY SCREEN

Removing a Profile

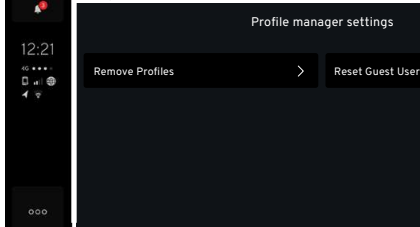

From a profile manager screen, tap the ○○○ settings button in the navigation bar.

Tap 'Remove Profiles' button.

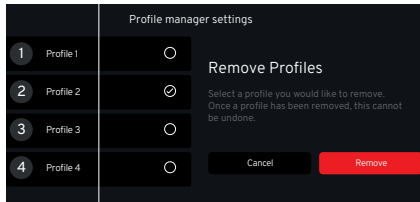

Tap the profile to be removed.

Tap 'Remove'.

Wrong Pin Code

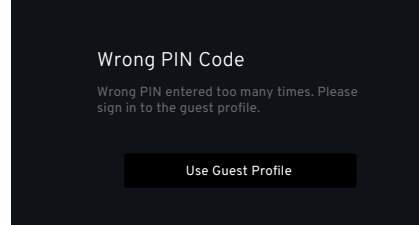

A driver profile will be disabled after 5 incorrect attempts to enter a PIN code. If this happens, tap the 'Use Guest Profile' button.

The vehicle settings will revert to the local settings already defined.

NOTE: A disabled driver profile cannot be recovered. Remove the profile and then recreate it as a new profile, see pages 106 and 105.

Editing a Profile

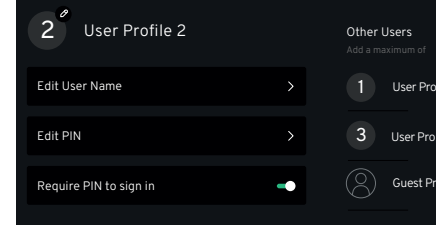

Edit Image

Tap on the profile image icon to access the 'Add new profile' screen.



Tap on any image that is highlighted (available), then tap the 'Next' button.

The display will return to the active profile screen.

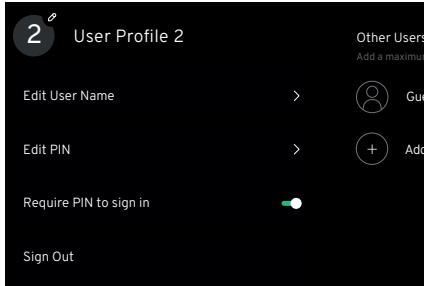

If required, the username and PIN code can be changed as shown on page 106.

Voice Assistant (If Available)

Using specific spoken commands via the infotainment microphone, some control options within certain vehicle systems such as climate control, media and Bluetooth-connected phone n can be controlled using voice assistant.

Voice assistant can respond with speech as well as showing information in the driver display.

It is recommended to learn the specific voice commands to ensure first time successful operation of voice assistant.

The voice assistant will only recognise commands using English, French or German languages, also see the language system settings options on page 100.

Using Voice Assistant



NOTE: Speak after the beep speaking in a normal voice and speed.

- Do not speak while the assistant is replying (the assistant cannot understand commands when replying).
- Close the windows and doors to avoid background noise in the vehicle cabin.

To change the voice assistant audio volume, turn the volume knob when the assistant is speaking.

Using the Driver's Display



Tap the  button on the left-hand steering wheel keypad to wake up the voice assistant.

The voice assistant will operate from the driver's display screen If the  button is tapped when in either the voice search/voice call screens for phone widget options are shown in the driver's display, see page 79.

CENTRE DISPLAY SCREEN

An audible beep and message on the screen indicates that the assistant is awake and listening for a voice command.

 **NOTE:** Commands from the driver's display are limited to phone options.

Using the Centre Display



Ensure that the voice search/voice call screens for any phone widget options are not shown in the driver's display.

Command Options Available

- Media*
- Mute/unmute media volume*
- Phone*
- Climate control, page 147.

*See separate infotainment guide.



 **NOTE:** Only certain functions of these vehicle systems can be controlled using voice assistant.



 Tap the  button on the left-hand steering wheel keypad to wake up the voice assistant.





An audible beep and a pop-up screen with a message will appear in the centre display. The assistant is now listening and you can say your command.

Cancelling Voice Assistant



From the steering wheel keypad either:
 Tap briefly on the  button and say "Cancel".

 Tap and hold the  button until you hear two beeps. This cancels the system even if the voice assistant is speaking.

From the centre display either:

 - If an  arrow is displayed in the screen, tap it to cancel voice assistant.
- Tap outside of the voice assistant pop-up screen.

 - Swipe left to right on the voice assistant pop-op to drag it out of the centre display.



 From the listening state either tap the  button the right-hand steering wheel keypad or say 'Cancel'.

Automatically Cancelling Voice Assistant

Voice assistant will timeout automatically when no speech or touch input is received in any state after 5 seconds.

It will cancel if Interrupted by any other application or system notification, (such as receiving an incoming call whilst speaking).



To interrupt a voice command, either tap the  button on the steering wheel keypad or tap the  and then give a new command as applicable.

LIGHTING

Exterior Lighting



Light Switch

Rotate the ring on the  stalk positioned on the left-hand side of the steering wheel.



Daytime Running Lights

These illuminate when the ignition is in mode II or engine is running.



Position Lights

The front and rear position lights, rear license plate and back lighting for switches and controls are illuminated.



NOTE: If the vehicle is in ignition position II then the daytime running lights are illuminated instead.

The position lamps can be switched on in any ignition position setting.

With the engine running but the vehicle stationary, the ring can be rotated to  from any other setting to only illuminate the position lamps.

After driving for a short time period or as vehicle road speed increases, the front position lamps are replaced by the daytime running lights.

If not already activated, the rear position lamps will illuminate if the tailgate is opened in low level ambient lighting conditions.



Low Beam Lights

With the engine running or with the vehicle's ignition in position II, low beam headlights, front and rear position and rear license plate lights are activated in this position.



This symbol is illuminated in the driver's display screen when either the position lights or low beam headlights are activated.

AUTO The low beam headlights, position and instrument panel lights automatically illuminate or extinguish depending on the ambient lighting conditions.





WARNING: The AUTO system cannot determine the ambient lighting conditions in every situation, (such as mist or rain). The driver must always ensure that the correct exterior light setting is selected for the current driving environment and in accordance with any applicable traffic regulations.

LIGHTING





High/Low Beam Headlights

- 1 High beam flash: Pull the stalk rearward toward you to activate.
 - 2 Constant high beam: With the lighting ring in either AUTO or  position, push the stalk forward to activate.
 - 3 Deactivate by pulling the stalk backwards.
-  This symbol is illuminated in the driver's display screen when the main beam lights are activated.



Rear Fog Light

If fitted, it is activated with the vehicle in ignition position II and either  or AUTO selected.

Press the  button on the front of the stalk to switch the light on or off.



 This symbol is illuminated in the driver's display screen when the rear fog lights are activated.

The switch will default to off whenever the headlamps or ignition are switched off.

 **NOTE:** The regulations on the use of rear fog lights may vary between different countries.



Direction Indicators

- 1 Short flash: Move the stalk up or down until resistance is felt and release. The indicator lamps will flash three times*.
 - 2 Continuous flash: Move the stalk up or down past the resistance point to its end position, the stalk will remain in this position.
-  The corresponding symbols illuminate in the driver's display screen during operating.
- 

The stalk will remain in position until moved back manually, or automatically by movement of the steering wheel.

*If the function is deactivated via the centre display, the lamps will flash once, see page 115.





Trip A Reset

Pressing the reset button on the end of the light switch will reset all information stored in the Trip A trip meter (trip distance, average fuel consumption and average speed). A notification message will briefly appear in the driver's display showing that trip meter 1 has been reset.

Also see page 72 for further information on trip meter options and resetting using the right-hand steering wheel keypad.



Hazard Warning Lights

To Activate: Press the  in the centre console. The switch, direction indicator lamps and  symbols in the driver's display will flash.

To Deactivate: Press a second time to switch off.

 **WARNING:** If stopped for an emergency, move the vehicle off the road, switch on the hazard warning lights and mark the vehicle with other warning devices as available to reduce the risk of a collision.



NOTE: Use of the hazard warning lamps may be subject to local traffic laws.

LIGHTING

Brake Lights

The brake lights are illuminated when the brake pedal is depressed, also see page 159.

Emergency Brake Lights

In the event of hard braking at road speeds over 50 km/h, sufficient enough to activate the anti-lock braking system, or, if the vehicle decelerates suddenly, the emergency brake light system is activated. The brake lights start flashing instead of being constantly illuminated. The brake lights will return to being constantly illuminated either upon driving away or when the rate of deceleration decreases. Also see page 160.

Reverse Light

When the gear lever is in position R the reverse light will illuminate and the rear parking assist system will be activated, also see pages 223 and 88.

Approach Lighting

The approach lighting is activated when the vehicle is unlocked by pressing the  button on the key fob. The position, courtesy and floor lights are activated. In dark ambient lighting levels, the number plate lighting and lighting in the outer handles are also activated with their light source aimed towards the ground.

The approach lighting will illuminate for approximately 2 minutes if no doors are opened. If a door is opened within the activation time, the time for the illumination of the interior lighting and lighting in the outer handles will be extended.

The functionality of the approach lighting is set from the centre display, see page 115.



Home Safety Lights

Some of the exterior lights can be kept illuminated after the vehicle has been locked.

1. Switch off the engine.
2. Move the left column stalk forward and then release.
3. Exit the vehicle and  lock the doors.

A symbol in the driver display is illuminated to indicate that the function is activated and the position, headlight low beam and licence plate lamps are illuminated.

The duration of lighting illumination is set from the centre display, see page 115.

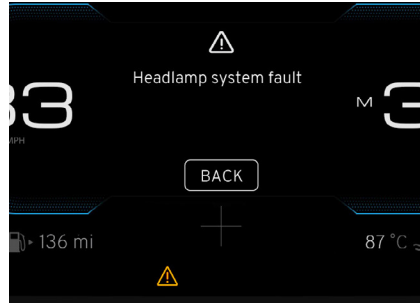

Light Failure

If a fault is detected affecting the exterior light system, the  symbol will illuminate in the driver's display screen. A message with information on the fault is also shown on the screen, also see page 61.

Exterior Lighting Presets

From the Global Settings and App Options button side bar in the centre display, select: Car > Exterior Lights.

See page 95 for further information.



LIGHTING

Interior Lighting



Overhead Console Switches

Press buttons to:

-  Illuminate/extinguish the left front reading light.
-  Illuminate/extinguish all interior lights.
- AUTO** Activate/deactivate interior lights courtesy mode.

In courtesy mode all interior lights:

- Illuminate with vehicle unlocked and when the ignition is switched off.
- Extinguish with engine started and when the vehicle is locked.
- Illuminate or extinguish when a door is opened or closed.
- Remain illuminated for 2 minutes if a door is left open.

- The indicator light on the button illuminates when AUTO function is active.
-  Press to illuminate the right front reading light.

Interior Lights

Reading lights are positioned in the roof lining by both sun visors.

Main lights are positioned in the roof lining above both front seats.

Glovebox Lighting

The light within the glovebox is illuminated/extinguished when the lid is opened or closed, see page 127.

Vanity Mirror Lighting

Lights within the sun visors (if fitted), illuminate/extinguish when the covers are opened or closed, see page 125.

Luggage Compartment Lighting

Lights within the luggage compartment switch illuminate/extinguish when the tailgate is opened or closed, see page 46.

Ambient Lighting

Lighting strips are located in the doors, instrument panels, centre console and cupholders and illuminate with the vehicle unlocked, ignition active or engine running.

Use the dimmer switch on the instrument panel to set the brightness levels see page 117.

Courtesy Lighting

If 'Auto' is selected from the overhead console, the footwell and roof lighting automatically illuminates when:

- The vehicle is unlocked.
- The engine is switched off.
- A door is opened.

The courtesy lighting automatically extinguishes when:

- The vehicle is locked.
- The engine is started.
- A door is closed.
- A door has remained open for more than 2 minutes.

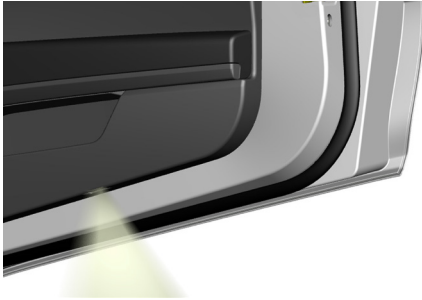

Ground Lighting

The ground light illuminates in low level ambient light conditions when a door is opened and extinguishes when closed.



Brightness Adjustment

Rotate the  control wheel positioned to the outboard side of the steering column to adjust the brightness levels for the instruments, ambient and mood lights.

WINDSCREEN, WINDOWS, MIRRORS AND SUN VISORS

Wipers/Washers



Wipers

To operate, move the stalk positioned on the right-hand side of the steering wheel to the required setting.

○ Windscreen wipers off.

▽ Single wipe: Press the stalk downwards from the 0 position and release, the wiper will sweep over the screen once at slow speed. Hold the stalk downwards for further slow sweeps until released.

! **CAUTION:** Before using the wiper check that the blade is not frozen and any snow or ice is scraped off of the windscreen.



Intermittent Wiping

AUT Set the wiper sweep interval by rotating the ring on the end of the stalk, upwards to increase the sweep interval, downwards to decrease the interval.

! **CAUTION:** Check the condition of the wiper blade regularly. A worn or damaged wiper blade rubber may not clean the windscreen properly.



Continuous Wiping

△ Wipers operate continuously at normal speed.

△ Wipers operate continuously at high speed.

WINDSCREEN, WINDOWS, MIRRORS AND SUN VISORS





Rain Sensor Wiping

The windscreen wipers activate automatically relative to the intensity of any rainfall sensed on the windscreen.

The rain sensor is activated when the ignition is set to I or II with the wiper stalk in AUT position.



The rain sensor symbol illuminates in the driver display when the function is activated.

Press the  button to activate the rain sensor, the  symbol in the driver's display will also illuminate.

Rotate the ring on the end of the stalk, upwards for greater sensitivity and downwards for less sensitivity. An extra sweep of the wiper blade is made when the ring is rotated upwards.

 **WARNING:** Do not use the rain sensing function if there is the potential risk that rain or washer fluid could freeze on the windscreen, this may obscure your vision.

Automatic Car Washes

 **CAUTION:** The windscreen wipers could start sweeping and become damaged in an automatic car wash. Ensure that the rain sensor function is deactivated when the engine is running or when the vehicle's electrical system is in ignition position I or II. The  symbol in the driver display is extinguished when the vehicle is in an automatic car wash.

Deactivating Rain Sensor Wiping

Press the  button again or move the wiper stalk upwards to another wiper setting.

In ignition position 0 or when the engine is switched off it is automatically deactivated.

WINDSCREEN, WINDOWS, MIRRORS AND SUN VISORS



Windscreen Washers

Pull the wiper stalk towards you to activate the washers. The wipers will also sweep the windscreen several times.

- CAUTION:** Use plenty of washer fluid when the wipers are cleaning the windscreen. The windscreen must be wet when the windscreen wipers are operating.

Washer Fluid Level



This symbol and a notification message will be shown in the driver's display if the fluid level becomes low in the washer fluid reservoir, also see page 189.



Power Door Windows

You can operate both of the vehicle's power windows using the window switches from the control panel in the driver's door panel. The passenger can operate their window by using the window switch in their door panel.

- 1** Moving the switches up or down slightly will raise or lower the windows for as long as the switches are held in position.
- 2** Moving the switches up or down fully, and then releasing will raise or lower the windows automatically to their end positions.

WARNING: Do not leave children unattended in the vehicle.

WARNING: Before closing a window, always check that no person or object will be trapped.

WARNING: Careless window operation could be dangerous, especially to children. Ensure that all passengers are also made aware of this danger.

WARNING: Do not leave children or animals in a parked car with the windows fully closed in hot weather conditions.

The vehicle must be in ignition mode I or II to operate the power windows. The power windows can be operated for a few minutes in ignition mode 0, (but not after a door has been opened). It is only possible to operate one switch at a time.

WINDSCREEN, WINDOWS, MIRRORS AND SUN VISORS

Automatic Drop/Raise

To ease door closure and optimise the sealing of the door glasses against the door seals, a fully raised window will automatically drop a small distance when the door is opened and rise again after the door is shut.

Pinch Protection

If either of the door windows is blocked by any object while opening or closing, the movement stops and then automatically reverses by 50 mm approximately from the blocked position (or to fully open position).

To override pinch protection when closing has been cancelled, e.g., when ice is formed, continue to press the window switch in the required direction.

If the battery supply is interrupted, the one touch down, auto drop and pinch protection features will not function which could increase risk of damage to the door window seals.

Resetting Automatic Drop/Raise/ Pinch Protection

- Fully raise each window, once raised, hold the switch for 2 seconds until a click is heard.
- Then fully lower each window, once lowered, hold the switch for 2 seconds until a click is heard.



NOTE: The windows cannot be opened at speeds above 180 km/h approximately, but they can be closed at any speed.



Door Mirrors

You can operate both of the vehicle's door mirrors, adjusting the mirror glasses using the switches and joystick within the control panel located in the driver's door panel.



WARNING: The mirror glasses are convex to provide a wider field of vision, but by so doing, make objects seem smaller and farther away.

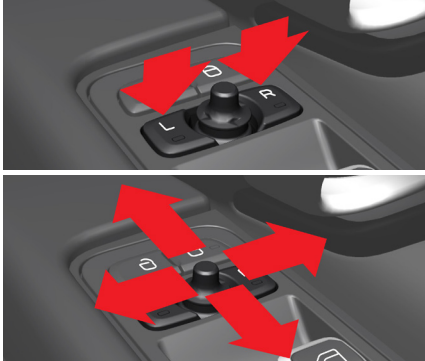

Adjusting the Door Mirror Glasses

- Press the L button for the left-hand door mirror or the R button for the right-hand door mirror.
- The light in the pressed button illuminates.
- Adjust the mirror glass positions using the joystick.
- Press the button again, the light will extinguish.

Folding/Unfolding the Door Mirrors

The door mirrors can be folded inwards for parking or driving into narrow spaces*.

Folding the Door Mirrors

- Set the ignition mode to I or above.
- Press the L and R switches simultaneously.
- Release them after approximately after 1 second and both door mirrors will automatically stop in the fully folded position.

Unfolding the Door Mirrors

- Press the L and R switches simultaneously again.
- The mirrors will automatically stop in the fully unfolded position.

*Optional accessory.

Automatic Folding When Locking

The door mirrors can be automatically folded/unfolded when the vehicle is locked/unlocked using the remote control keys.

The preset option for this feature is set within the centre display, see page 95 for further information.



NOTE: If the mirrors have been folded inwards using the L and R buttons, they must be folded out manually.

Resetting to Neutral

Door mirrors that have been moved out of position by an external force must be reset electrically to their original positions for electric retracting/extending to work correctly*.

- Fold in the door mirrors by pressing down the L and R buttons simultaneously.
- Fold them out again by pressing the L and R buttons simultaneously.
- Repeat the above procedure as necessary to return the mirrors to their original positions.

*Optional accessory.

WINDSCREEN, WINDOWS, MIRRORS AND SUN VISORS

Manual Angling During Parking

Door mirror glasses can be angled down for the driver to view the side of the road when parking*.

- With reverse gear engaged, press the L or R switches as required.
- Note that the switches may need to be pressed twice, depending on whether it was already preselected.
- The switch flashes when the door mirror glasses are angled down.
- With reverse gear disengaged, the door mirror glasses automatically start to return after 3 seconds and then reach their original position after 8 seconds approximately.

*Only applicable if power seats with memory buttons are fitted.

Automatic Angling During Parking

The door mirror glasses can be automatically angled down when reverse gear is selected.

This feature is set within the centre display, see page 95 for further information.

 **NOTE:** Pressing the L or R switches twice will return the glass to its original position.



Interior Rearview Mirror

Manual Dimming

The interior rearview mirror can be dimmed using the lever on the mirror base.

- Dim the mirror by moving the lever towards you.
- Return to normal view by moving the lever towards the windscreen.

 **NOTE:** The control for manual dimming is not available on mirrors with automatic dimming.

Automatic Dimming Mirror

Bright light from behind the vehicle, reflected from the rearview and door mirrors is automatically dimmed*.

Except for when the ignition is off or reverse gear is selected, automatic dimming is always active.

The preset dim levels for this feature are set within the centre display, see page 95 for further information.

*If option fitted.



NOTE: The dimming function of the interior rearview and door mirrors will be reduced if these sensors are obscured by objects such as parking permits, transponders or sun visors etc, that may prevent light from reaching the sensors.



Sun Visors

Sun visors (if fitted) are located in the roof lining in front of the seats and can be folded down when necessary. They can also be unclipped from their inner mountings and rotated if required.

With the visors in the down position, vanity mirrors in the visors are illuminated when the mirror covers are lifted up.

CABIN STORAGE AND POWER SOCKETS

CABIN STORAGE AND POWER SOCKETS

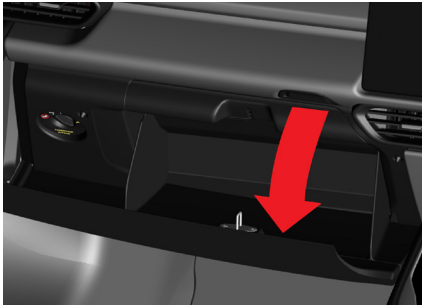

Glovebox

Located on the passenger side fascia, press the release button above the glovebox to open. To close push fully closed and the latch will engage.

Centre Console

The centre console has several storage areas.



Armrest

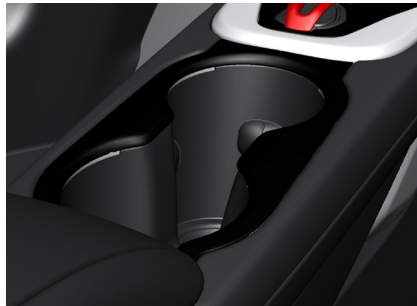

Cup Holders



Below Climate Control Switches

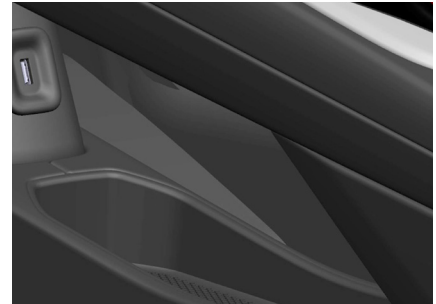

Below Gear Selector

(Automatic transmission centre console shown, storage tray in manual transmission console is smaller).

CABIN STORAGE AND POWER SOCKETS



Door Pockets

Luggage Nets

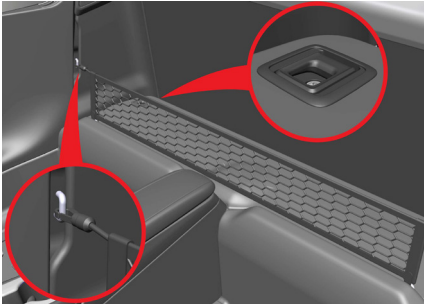

Rear Cabin Net
(If fitted).

 **WARNING:** The maximum luggage weight must not exceed 20kg. Any luggage stored must be fully enclosed within the net to avoid becoming insecure in the vehicle.

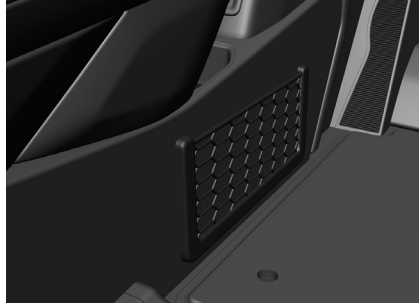

Centre Console Net

Power Sockets



12 Volt Power Socket

A power socket is located at the rear of the centre console. It is active in ignition mode I or II.

If the engine is switched off and the vehicle is locked, the power socket and USB ports are deactivated. If the engine is switched off and the vehicle is not locked, then the socket and USB ports continue to be active for a further seven minutes.

WARNING: Do not leave small children unattended in the vehicle since careless interference with the power socket could be dangerous.

WARNING: Do not use accessories that can cause interference to the vehicle's radio or electrical systems.

WARNING: The connected accessory should be put in a position so that it cannot injure the vehicle occupants in the event of heavy braking or collision.

WARNING: Frequently check any connected accessories as they can generate heat that can burn occupants or the interior.

CAUTION: The battery may become discharged if the auxiliary socket or USB ports are used when the engine is switched off.

CAUTION: Accessories exceeding a 10 amp rating should not be used. Check the rating of any accessory before plugging it into the power socket.

USB Ports

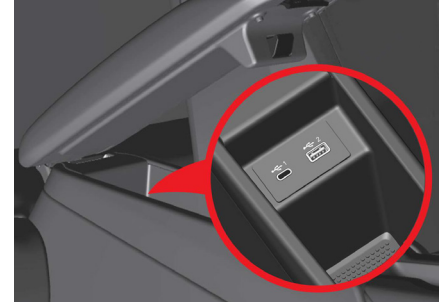

In Armrest

2 USB ports (type A and C) are fitted inside the centre console armrest. These can be connected to the infotainment system for data transfer and phone projection.

CAUTION: The USB port output voltage is 5V and the maximum current is approximately 2.5A. Do not connect devices such as fans or lights to the USB ports.

CABIN STORAGE AND POWER SOCKETS



Front of Centre Console

A single type A USB port is fitted forward of the centre console's lower storage tray, which is used for device charging only.

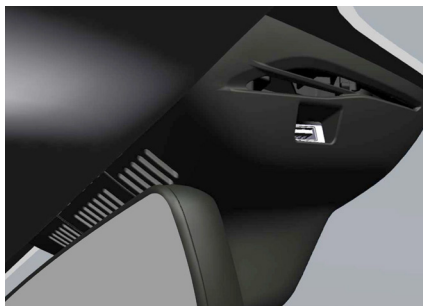

Rearview Mirror

A USB port is located at the front of the rearview mirror trim, intended for supplying power to a traffic video recorder.



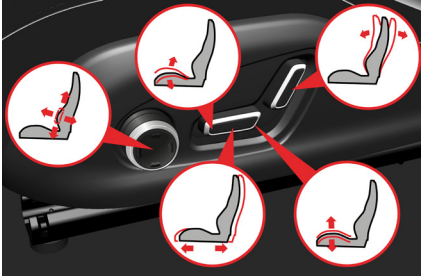

SEATS AND STEERING WHEEL

SEATS AND STEERING WHEEL

Seats







Power Seats

-  Adjust the lumbar support by pressing the top/bottom/front/rear part of the switch.
-  Adjust the angle of the seat cushion by moving the front of the switch up/down.
-  Adjust the height of the seat cushion by moving the rear of the switch up/down.
-  Adjust the angle of the backrest by moving the control forwards/backwards.
-  Move the seat forwards or backwards by moving the control forwards/backwards.

Seat Fold

See page 134.

-  **WARNING:** To prevent personal injury that could be caused by sudden braking, ensure that the seat is locked in position before driving.
-  **WARNING:** Sit as far back from the steering wheel as is comfortable, whilst ensuring that the brake pedal can still be fully depressed and that full control of the vehicle can be maintained.
-  **WARNING:** Ensure that no persons or objects will be trapped when adjusting the seat.
-  **WARNING:** Do not attempt to adjust the seat position whilst driving as this could adversely affect your control of the vehicle.

 **NOTE:** Two of more of the power seat's control switches cannot be used at a time.

 **NOTE:** The power seats have an overload protection system that is activated if an object is restricting seat movement. If this occurs, remove the object and then move the seat again.



Seat/Door Mirror Memory Switches

Memory buttons are located on the driver's door panel for vehicles fitted with power seats. The memory function can store two different settings for the driver seat and door mirrors.

Storing Memory Settings

To store a seat/door mirror position in memory button 1:

- Set the vehicle to ignition 1, or have the engine running, see page 149.
- Adjust the seat and door mirrors to the desired position, see pages 132 and 122 .
- Press the M button and release. The indicator light in the button will illuminate.
- Within a short period, press and hold button 1 until the indicator light in the M button extinguishes and a chime is heard.



NOTE: Use Button 2 in the same way to store another set of seat/mirror positions.

Activating a Stored Setting

With the driver door open:

Press button 1 and release. The seat/door mirrors will automatically move to the stored position.

With the driver door closed:

Press and hold button 1 until the seat/door mirrors stop moving.



WARNING: Do not use the memory function or adjust the seat when the vehicle is moving. This could cause loss of vehicle control.



WARNING: The driver's seat can be adjusted with the ignition in mode 0, therefore children should never be left unattended in the vehicle.



CAUTION: Obstructions to the seats movement could cause damage to the seat.



NOTE: The lumbar position setting is not stored.

SEATS AND STEERING WHEEL

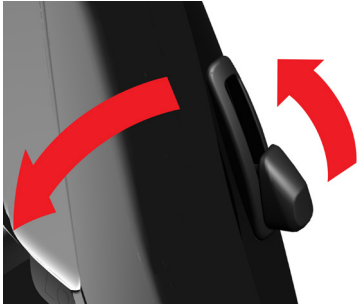

Seat Fold

Pull the strap on the outboard rear of the seat to fold the backrest and move the seat forwards. The seat will return to its original position after releasing the lever.

Seat Heating

See page 143.



Horn

To sound press the centre pad area on the steering wheel.

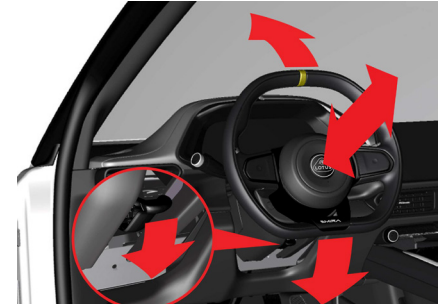

Steering Wheel Adjustment

The steering wheel can be adjusted for both height and depth*.

1. To release the steering wheel, push the column lock lever downwards.
2. Adjust the steering wheel to your ideal height and depth position.
3. To lock the steering wheel in position, pull the column lever back.
4. Try to move the steering wheel up, down, in and out to ensure that you have locked it securely.

⚠ WARNING: Ensure that the steering wheel is in the correct position and locked securely before driving. Never adjust the steering wheel whilst driving.

The door mirrors and driver seat should also be adjusted to a safe and comfortable position before driving, see pages 122 and 132.

*Right-hand vehicle shown.

Electronic Steering Column Lock

When the ignition is in mode 0 and the vehicle is stationary, the electronic steering column lock will activate (lock), when:

- The vehicle is locked using the remote control key.
- A certain time period has elapsed with the ignition mode 0.
- The vehicle is not started within a certain time period after unlocking the vehicle.

CLIMATE CONTROL

Climate Control System

Either manual climate or automatic climate control can be selected. The bespoke Lotus climate system provides heating, ventilation and also cools and dehumidifies the air inside the vehicle cabin.

Climate system options are selected from the climate control switches in the centre console as well as the on-screen buttons in the centre display.

To get the best results from the climate control system:

- The windows should be closed for optimal performance.
- Clear any snow, ice or blockages from the air inlet in front of the windscreen to ensure the best operation of the system.



NOTE: To ensure that the air conditioning system is kept in good condition, and the compressor lubricated, it is recommended to select air conditioning at least for a few minutes every week.



Climate Control Switches

- 1 Temperature control and air conditioning on/off.
- 2 Air distribution.
- 3 Windscreen demister.
- 4 Heated rear screen/door mirrors.
- 5 Air recirculation.
- 6 Fan speed/auto climate mode on/off.



Air Conditioning

With the engine running and the climate fan on:

- Press the A/C button to activate the air conditioning.
- The indicator lamp in the button illuminates and the A/C symbol appears in the centre display.
- Press the button again to deactivate.

The air conditioning system can also be activated by:

- Pressing AUTO button.
- Pressing the windscreen demister button.

See page 143 for centre display settings.

CLIMATE CONTROL



Air Temperature

To adjust the cabin air temperature, rotate the control ring around the A/C button clockwise to increase temperature and counter-clockwise to decrease.

The temperature setting temporarily appears in the centre display as well as being permanently shown on the climate navigation bar of the centre display.

See page 143 for centre display settings.



Air Distribution

Air flow enters the vehicle cabin by a combination of the:

- Windscreen demister and side window air vents.
- Footwell air vents.
- Face level instrument panel air vents.

The current air distribution setting temporarily appears in the centre display as well as being permanently shown on the climate navigation bar of the centre display.

Pressing on the air distribution switch briefly changes/cycles the air flow between a combination of these vents, providing 6 different settings.



See page 143 for centre display settings.



Manual recirculation cannot be selected with the demister active.

Demister

Press the demisting switch for maximum windscreen demisting/defogging. When activated:

- The indicator lamp above the switch illuminates and a demister symbol temporarily appears in the centre display.
- The climate fan will operate at full speed.
- All airflow is directed to the windscreen.
- Maximum heat is selected.
- Air conditioning is activated.
- Press the switch again to deactivate. Demister function will also deactivate if the ignition mode is set to 0.



Heated Rear Screen/Door Mirrors

With the engine running, press the rear screen/door mirror switch to activate the rear window defrost function. When activated:

- The indicator lamp above the switch will illuminate.
- The rear screen and the door mirrors will begin defrosting.
- Press the switch again to deactivate, but will automatically cancel after 10 minutes approximately.

The heated rear screen can also be set to automatically activate in cold temperature conditions using the controls in the centre display, see page 143.

CLIMATE CONTROL



Air Recirculation

Press the recirculation switch to prevent fumes from other vehicles etc from entering the cabin, or for maximum cooling when using the air conditioning. When activated:

- The indicator lamp above the switch illuminates and a recirculation symbol temporarily appears in the centre display.
- The interior air is recirculated inside the vehicle.
- Press the switch again to deactivate.



WARNING: Do not use the recirculation mode for long periods as it may cause the interior air to become stale and the windows to mist up.

It is not possible to activate air recirculation when the demister is activated.

See page 143 for centre display settings.



Auto Climate

Press the AUTO button to activate automatic climate system. When activated:

- The indicator lamp in the button illuminates.
- The airflow temperature, distribution and climate fan speed are then controlled by the vehicle to maintain your desired temperature.
- Press the button again to deactivate.

The auto mode will deactivate if one of the following occurs:

- Recirculation mode is activated.
- The demister is activated.
- The air distribution switch is pressed.
- The climate fan speed is adjusted.

See page 95 for centre display settings.

Automatic Climate Temperature

The desired regulated climate in the vehicle cabin is based on the temperature perceived by the system, not the actual temperature.

This perceived temperature is influenced by ambient temperature, air speed, humidity, solar radiation, etc. that the vehicle is currently subjected to.

A sensor detects which side of the vehicle the sun is entering into the cabin, which means that the airflow temperature between the air vents may be different even though the system is attempting to regulate the temperature.

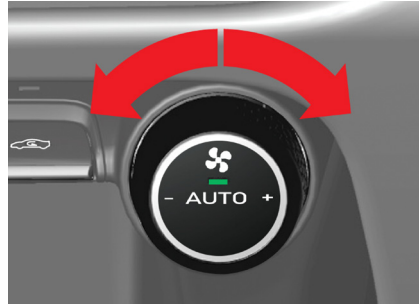

Climate Fan

To adjust the climate fan speed, rotate the control ring around the AUTO button clockwise to increase fan speed (seven speeds are available). Turn counter-clockwise to decrease (down to fan off).

An indication of the fan speed level temporarily appears in the centre display as well as being permanently shown on the climate navigation bar of the centre display.

See page 143 for centre display settings.



Air Vents

Adjustable air vents* are positioned in the centre and outboard of the fascia on both sides.

Non adjustable vents direct airflow to the windscreen and footwells.

* Right-hand vehicle shown.

CLIMATE CONTROL



Adjusting Air Vents

Move the lever within the vent to direct airflow to the direction required.

Pollen Filter

A pollen filter is to clean all air entering the vehicle cabin.

Pollen Filter Replacement

To maintain air quality entering the vehicle, the filter should be renewed by your Retailer at intervals specified in the vehicle maintenance schedule.

If the vehicle is driven in an exceptionally dusty/sandy environment, filter replacement may be required more often.

Contact your Lotus Retailer for more details if necessary.

Interior Air Cleaning System

An air quality sensor detects contaminants in the air outside of the vehicle. When excessive contaminant levels are detected, the cabin fresh air intake vent closes and the air inside the cabin is recirculated to avoid high pollution.

The system will not activate when:

- The recirculation mode is already active.
- The climate fan is not on.
- The windows are open.

Active Electrical Module Cooling

When required, cooling air from the climate system is diverted to some of the electrical modules positioned behind the dashboard area to ensure optimal performance.

If activated, the climate fan and air conditioning functions may automatically activate or adjust their current settings.

Centre Display

Additional climate control settings, as well as those also activated by the switches can be controlled from the centre display screen.



Presets Bar

From the side bar of the centre display, select: Global Settings/App options > Car > Climate.

- A Recirculation Timer:**
Automatic cancellation 30 minutes after activation.
- B Fan Intensity Auto Mode:**
Low, medium and high intensity level options.
- C Auto Rear Defrost:**
Heated rear screen automatically activates below temperatures of 7°C.
- D Auto Start Seat Heating:**
Available when in ignition mode II (active), set the duration period of automatic seat heating.

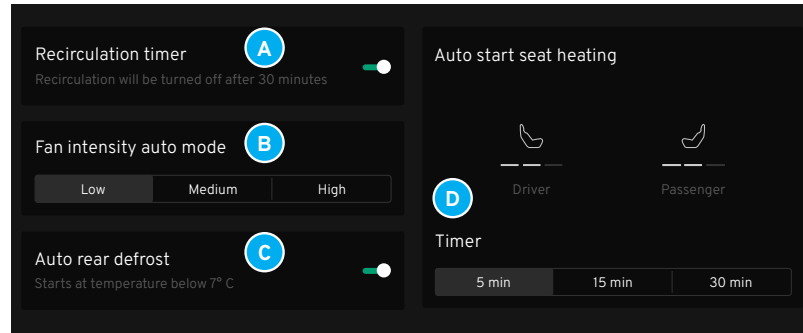
See page 95 for information on the centre display screen.



-  Tap the required climate option.
-  Use the slide button to activate the preset.
-  If preset levels are available, tap on the toggle buttons to select the level required.

Seat Heating

See page 145 for further information on using the toggle buttons to change the seat heating levels.

CLIMATE CONTROL

Navigation Bar

22.5° From the navigation bar in the centre display, select the climate control icon to show the available options.



Available Climate Controls

- A** Temperature.
- B** Air distribution.
- C** Fan speed.
- D** Left side seat heat.
- E** Max A/C.
- F** Auto climate.
- G** Recirculation.
- H** Right side seat heat.

See page 95 for further information on the centre display screen.

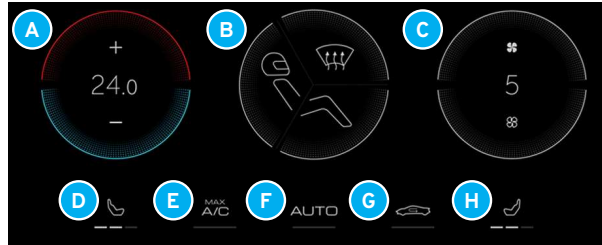

A Temperature

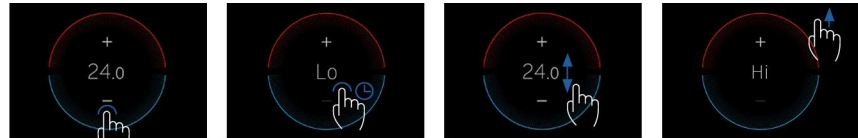

Tap '+' or '-', changes the temperature by 0.5°.

Long press the '+' or '-', sets the temperature to 'Hi' or 'Lo'.

Press and drag up or down inside the display to change the temperature.

Press and drag up just outside of the display to set 'Hi' temperature.

B Air Distribution

Tap on the bottom, middle or top area of the air distribution display to activate or deactivate a zone.



Windscreen



Footwell



Face

C Fan Speed



Tap inside display to increase or decrease the speed by one level.



Long press inside display to set speed to '7', or 'OFF'.



Press and drag inside display to change the speed.



Press and drag outside display to set fan speed to '7'.

D H Heated Seat Temperature

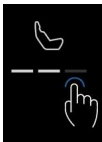

Repeatedly tap the toggle button to change the heating levels for the driver and passenger seats between: Off, High, Medium and Low.

WARNING: Persons who have difficulty in perceiving increasing temperature due to a lack of sensation or have problems operating the controls should not use the heated seat option as this may result in burn injuries.

E Maximum A/C



Pressing the 'MAX A/C' toggle button or by setting the temperature to 'Lo', will activate maximum A/C.

NOTE: Auto climate will be deactivated if previously selected.

When activated, the indicator lamp below the toggle button illuminates, the temperature is set to 'Lo' and the climate system will attempt to lower the cabin temperature to as cold as possible by adjusting the climate fan speed, air distribution settings and activating the air conditioning (if not already activated).

Press the toggle button again to deactivate Max A/C, or:

- Change the temperature.
- Change the climate fan speed and air distribution settings.
- Deactivate the air conditioning.
- Activate auto climate setting.

CLIMATE CONTROL

F Auto Climate



Setting Auto Climate

Set the temperature to the desired level and then activate auto climate by pressing the toggle button in the central display or by pressing the AUTO button in the centre console, see page 140.

- The indicator lamp below the toggle button illuminates.
- The climate fan speed level and the air distribution indications within their displays are dimmed.

The climate system will now adjust the speed, distribution and amount of cold air introduced into the cabin to maintain the desired temperature.



Setting Climate to Off

Set the climate fan speed level to 'OFF' from the central display or by using the control ring around the AUTO button in the centre console, see page 140.

- 'OFF' is shown in the climate fan speed display.
- The temperature level within the temperature display is dimmed.
- Airflow distribution is deactivated.

To Reactivate Climate:

- Tap the '+' button within the temperature control display.
- Increase the climate fan speed level from the central display or by using the control ring around the AUTO button in the centre console.

G Air Recirculation

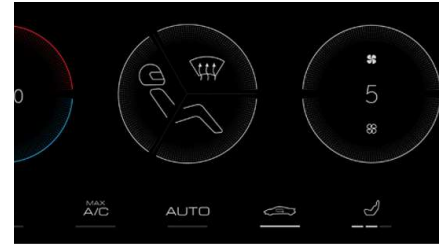

Setting Air Recirculation

Press the toggle button in the central display or press the recirculation button in the centre console, see page 140.

- The indicator lamp below the toggle button illuminates.
- The interior air is recirculated inside the vehicle.
- Press the toggle button again to deactivate.

Voice Assistant (If Available)

Some climate control functions can be controlled using voice assistant via the centre display screen, also see page 107 for activating voice assistant.

Seat Heating

Voice Commands

- }}) - "Set Seat heating to level 1".
- }}) - "Turn up seat heating level".
- "Set seat heating level lower".
- "Decrease seat heat".

Climate Fan

Voice Command

- }}) - "Decrease the fan speed to the minimum".
- "Reduce the fan level".

Demister/Air Conditioning

Voice Command

- }}) - "Switch on front window defrost".
- "Set the air conditioner to 24 degrees Celsius".

STARTING AND DRIVING



Ignition Modes

To change the ignition mode from mode 0 (inactive, with the vehicle unlocked and driver's door opened), press the START/STOP ENGINE button WITHOUT depressing the clutch (manual powertrain vehicles) or brake pedal (automatic powertrain vehicles).

Ignition mode I (Convenience)

With the keyfob detected, a brief press on the START/STOP ENGINE to change to mode I from 0.



Ignition mode II (Active)

With the keyfob detected, a long press on the START/STOP ENGINE for around 5 seconds to change to ignition mode II from modes 0 or I.

Electronic Steering Column Lock

When the ignition is in mode 0, (inactive) and the vehicle is stationary, the electronic steering column lock will activate (lock), when:

- The vehicle is locked using the keyfob.
- A certain time period has elapsed with the ignition in mode 0.
- The vehicle is not started within a certain time period after unlocking the vehicle.

Ignition Mode	Systems Available
 0 - Inactive	Some electrical functions can be used in this mode within a limited time period. The clock, audio infotainment and position lights can be used. The electronic steering column lock is also deactivated (unlocked).
 I - Convenience	Certain convenience functions can now be operated, such as the power windows, phone, etc.
 II - Active	Exterior lights can be operated. The electrical systems will perform self-checks and the warning alerts symbols will illuminate in the driver display for approximately 3 - 6 seconds. Most electrical controls can now be operated.

STARTING AND DRIVING

Starting the Engine

- Ensure the keyfob is in the front seat area.
- Manual vehicles: Check that the transmission is in neutral and depress the clutch pedal, see pages 151 and 152.
- Automatic vehicles: Select P – Park or N - Neutral and apply light foot pressure to the brake pedal, see pages 153 and 159.





- Lift the rear of the START/STOP ENGINE button flip cover.
- Press and release the START/STOP ENGINE button, the autostart function will operate the starter motor until the vehicle starts.

 **WARNING:** To maintain vehicle control, ensure that sure that the driving seat, steering wheel and door mirrors are adjusted correctly.

 **WARNING:** If necessary, adjust the driving seat to ensure that the brake pedal can be fully depressed.

 **WARNING:** Ensure that you and any passenger in the vehicle fastens their seatbelt before driving.

 **WARNING:** Never remove the keyfob from the vehicle or press the START/STOP ENGINE button when the vehicle is moving. This could stop the engine and cause an accident.

 **CAUTION:** Do not accelerate a cold engine immediately after starting. Oil may not lubricate all engine components and could cause engine damage.



Emergency Starting

A message is shown in the driver display if the keyfob battery is low and cannot be detected.



Key not in car

If this message is shown and the engine will not turn over then:

- Place the keyfob in the recess towards the rear of the storage area within centre console arm rest.
- Press the start button.
- The alarm siren will silence and the alarm is deactivated.

NOTE: When the remote control key is positioned by the backup reader in the front cup holder, make sure that there are no car keys, metal objects or other electronic devices also in the cup holders, (such as mobile phones, or chargers). Devices close together by the backup reader may cause interference with each other.

NOTE: If the does not start after 3 attempts, wait for 3 minutes before making a further attempt.

Switching off the Engine

- Ensure the vehicle is stationary, the parking brake applied and the transmission is in neutral (manual vehicles), or in P- Park (automatic vehicles). Also see pages 162 and 153.
- Lift the rear of the START/STOP ENGINE button flip cover.
- Press and release the START/STOP ENGINE button and the engine will stop.



WARNING: Always take the remote control key out from the vehicle when exiting and ensure the vehicle is in ignition mode 0 (especially if a child is left in the vehicle).

Transmission

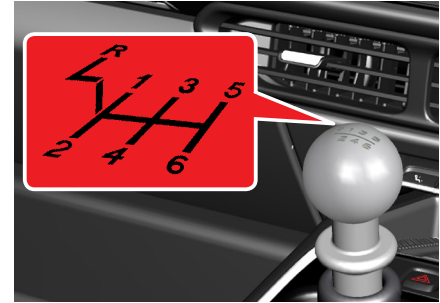

Manual Transmission

The manual transmission has 6 forward gears with the gear shift lever pattern shown on the gear knob. The clutch pedal must be fully depressed during each gear change and the throttle pedal eased during upshifts.

WARNING: Always apply the parking brake when parking on an incline/hill. Leaving the vehicle in gear may not be sufficient to hold the vehicle.

STARTING AND DRIVING



Selecting Reverse Gear

With the vehicle stationary, and the clutch pedal fully depressed, lift collar beneath the gear knob and move the gear shift lever fully over to the left, then forwards to engage reverse gear.

The park assist camera will also automatically* activate showing the view from the rear of the vehicle in the centre display.

*Dependent on market.

! **CAUTION:** Changing gear without correct clutch and throttle operation can result in transmission and engine damage. Never attempt to engage reverse gear while the vehicle is moving forward. This may result in serious transmission damage which is not covered by the vehicle warranty.

Clutch Pedal

For manual transmission vehicles the clutch pedal must be fully depressed to start the engine. Ensure that clutch pedal movement is not obstructed by a floor mat or any other object before driving.

! **WARNING:** Any floor coverings in the footwell must be properly secured. Loose mats can interfere with the operation of the foot pedals causing possible loss of vehicle control.

Automatic Transmission

The Lotus automatic transmission system allows the driver to switch between conventional 6 speed automatic drive to manual shift mode with the option of sport and track modes producing quicker and more pronounced gear shifts as well as optimising shift points for performance.

System Modes

Automatic Transmission

Gear shifts and shifting points are biased to optimise refinement and fuel economy.

Manual Selection

Forward gears can be sequentially manually selected using either the gear selector or paddle shifters behind the steering wheel.

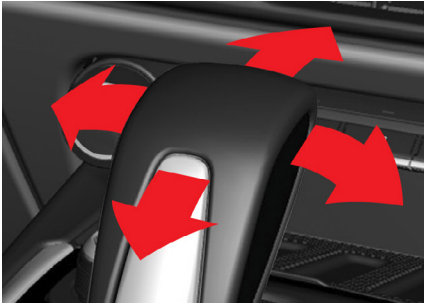

Gear Selector

With the vehicle in ignition mode II, the following gears can be selected from the gear selector.

- P - Park
- R - Reverse
- N - Neutral
- D - Drive

The engine can only be started if either P or N are selected with the footbrake depressed.

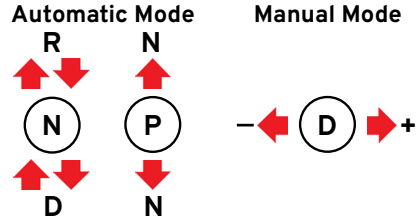

Selecting Gear

Dependent on the gear currently selected, firmly depress the footbrake and move the gear selector forward or rearward once or twice to shift between gears.

To select R, if D is currently selected, depress the footbrake, move the gear selector forward to select N, release the pressure and let it spring back then move it forward again to select to R.

⚠ WARNING: Always depress the footbrake firmly whilst selecting D or R, as the vehicle may move even if the throttle is not depressed.

STARTING AND DRIVING

WARNING: To avoid unexpected or sudden vehicle movement always select P or N if the vehicle is stationary with the engine remaining at idle for prolonged periods.

NOTE: To avoid unexpected or sudden vehicle movement wait for the transmission to engage gear after selecting D or R before depressing the accelerator pedal.

A warning message will appear in the driver's display screen if attempting to select a gear or start the vehicle without the footbrake depressed.

It is good driving practice to only turn the engine off once the vehicle is stationary and P or N has been selected.



P – Park

With the vehicle stationary, apply the parking brake and press the P button behind the gear selector to activate Park mode. Move the selector lever forward/rearward once to deactivate park mode.

WARNING: Always apply the parking brake as well as selecting P to keep the vehicle stationary.

CAUTION: To avoid engine and transmission damage, the vehicle must be stationary before selecting P.

NOTE: To lock the vehicle and arm the alarm, the transmission must be in P.

NOTE: If the engine is switched off and a door is opened, an audible warning will sound to remind you to select P.

Automatic Park Activation

Park will automatically be selected:

- When the engine is switched off in position D or R.
- The driver unfastens their seatbelt and opens the driver's door when the engine is running in any other gear.

R - Reverse

Firmly depress the footbrake and select R to reverse the vehicle. Always stop the vehicle completely before selecting R. The park assist camera will also automatically* activate showing the view from the rear of the vehicle in the centre display.

*Dependent on market.

N – Neutral

No gear is engaged with neutral selected. Only select N when the parking brake is applied and the vehicle is stationary. The engine can also be started when the transmission is in neutral.

Neutral can also be selected from any gear by simultaneously pulling both steering wheel mounted paddle shifters towards the driver.



NOTE: The brake pedal must be depressed and the ignition must be in mode II before you can select any other gear from N.

D – Drive

Depress the brake pedal and select D only when the vehicle is stationary to engage forward gears.

Gear changing shifting points are controlled by information received by the vehicle's engine management systems.

Unsuitable PRND Selection

If an unsuitable PRND request is selected (such as selecting reverse whilst the vehicle is moving forward in drive or if the footbrake has not been depressed), the current gear selected will remain highlighted in the driver display screen, a warning message is displayed and the transmission will not engage the gear requested.

Drive Selection in Manual Mode

Drive can also be selected from P, R or N by depressing the footbrake and holding the '+' paddle shifter towards the driver. Also see page 157.

The footbrake does not have to be depressed if the vehicle is moving. Also see page 156.

Kick-Down

With the transmission in automatic mode, depressing the accelerator pedal fully will downshift the transmission into the lowest suitable gear. Once the accelerator pedal is returned to a normal driving position, the transmission will up-shift to the highest suitable gear. Kick-down operation will vary according to road speed, current gear in use and accelerator movement.

Transmission Warning Messages



This symbol will illuminate accompanied by an explanatory message in the driver's display if a fault has been detected within the transmission system. Dependent on the fault detected the vehicle may default to a limited power mode. If this occurs ensure to adhere to the message displayed (which may include stopping the vehicle) and contact your Lotus Retailer.

STARTING AND DRIVING



Manual Selection Mode

Two driver controlled options are available

Permanent Manual Mode

Initially activated by using the gear selector lever and then maintained by using the gear selector lever or paddle shifters until automatic mode is reselected.

Temporary Manual Mode

Initially activated by using the paddle shifters, returning to automatic mode if the paddles are not used again within a certain time period. See page 157.

With either mode selected, gear shift indicator arrows, 'M' and the gear currently selected are shown in the driver display screen.



NOTE: Kick-down is not available in manual mode.



Activating Permanent Manual Mode

Activate whilst driving in D by moving the gear selector to the right or left.

Using the Gear Selector

- Move the gear selector to the right (toward "+") then release, the transmission will remain in the current gear automatically selected. Continue to move the gear selector lever to the right to shift up into higher gears.
- Move the gear selector to the left (toward "-") then release to immediately shift down into the next lower gear available.

Once in permanent mode you can also use the paddle shifters and still remain in permanent mode. The engine will not

automatically upshift before reaching maximum engine speed (rpm), when in permanent manual mode, but will still downshift at minimum engine speed.



Activating Temporary Manual Mode

Pull one of the paddle shifters positioned behind the steering wheel towards you to activate the temporary manual mode.

Up-shifting: Controlled by the “+” right hand paddle.

Down-shifting: Controlled by the “-” left hand paddle.

Pull the required paddle towards you to sequentially up-shift or down-shift gear

If the engine speed remains within the permitted rpm range then the transmission will change gear with each pull of a paddle.

! **CAUTION:** The use of high engine rpm before normal running temperature has been reached should be avoided. To reduce possible damage and wear the use of maximum engine speed should be restricted to occasions when maximum acceleration is required. Overuse will compromise powertrain service life.

Before maximum engine speed (rpm), is reached, the transmission will automatically upshift.

If not already selected by the driver, lower gears will be automatically selected by the transmission as the vehicle road speed decreases to protect the transmission system and prevent the engine from stalling.

Unsuitable Gear Selection

If an ‘unsuitable’ gear shift is attempted which could cause the engine to reach its maximum rpm, then the current gear selected will remain unchanged and still be shown in the driver display screen.

STARTING AND DRIVING

Remaining in Temporary Manual Mode

Continued operation of either paddle within 20 second intervals will maintain manual selection.



If a paddle is not operated within a 20 second interval then the transmission will return to automatic mode selecting the appropriate gear, which may differ from the gear last manually selected. A timer with four dashes shown underneath the 'M' in the driver display counts down when the gear mode will switch back to automatic mode.

 **NOTE:** To protect the transmission, it will downshift at the lower rev band to prevent engine stalling.

Temporary to Permanent Mode

To change from temporary to permanent manual mode, move the gear selector to either the right (toward “+”) or left (toward “-”), see page 156.

Deactivating Manual Selection Using the Gear Selector:

– Move the gear selector rearward to select D.

Or;

– Move the gear selector forward to select N.

Using the Shift Paddles:

– Pull “+” up-shift paddle for 2 seconds.

Or;

– In temporary manual mode, do not make a gear selection with either paddle shifter for 20 seconds or more.

Sport & Track Modes

Sport and track modes (if available) are provided for the preferences of some drivers.

Refer to page 164 for further information on the suitable conditions for activating sport, track and ESC (Electronic Stability Control) ‘Off’ modes as well as appropriate safety warnings.



NOTE: Switching off the Electronic Stability Program in conjunction with the selection of sport or track mode, will still retain the enhanced engine and transmission sport features, but without any power-induced wheel slip intervention. Anti-lock Braking System and Hydraulic Brake Assist will be retained in any mode selected.

See page 161 for further information on the Electronic Stability Control.

Braking System

Footbrake

Ventilated disc brakes are fitted to all four wheels. These are operated by two separate hydraulic brake circuits which operate independently. If one brake circuit fails, the other will still operate but with reduced brake performance resulting in increased vehicle stopping distance.

 A brake system fault has been detected, or the level of the brake fluid is low if this warning symbol is shown in the driver's display at any other time than briefly during engine start up. A basic fault description message will also be displayed.

Contact your Lotus immediately if you think there is reduction in the braking performance of your vehicle or if a warning symbol and message is shown in the driver's display.

 **WARNING:** Failure to follow the above instruction may result in an accident.

The brakes are assisted by vacuum pressure which is only generated when the engine is running. The brake pedal will feel stiffer and greater pressure must be applied to stop the vehicle if the brake pedal is depressed when the engine is switched off, or if the vacuum assist fails to operate.

 **WARNING:** Never drive the vehicle if the engine is not running or switched off because greater pressure on the brake pedal will be required to slow the vehicle, increasing stopping distance.

A reduction in braking performance may be experienced after driving through a ford or flood until the brakes have dried out. If this happens, apply the brakes as soon as it is safe to do so until normal braking performance is restored.

 **WARNING:** Failure to follow the above instruction may result in an accident.

Brake Pedal

Always check the movement of the brake pedal before driving and make sure that it is not obstructed by a floor mat or any other object.

 **WARNING:** Any obstruction of the brake pedal could increase the stopping distance.

Brake Pads

Note that the hard grade of the pad material may cause a certain amount of brake noise under some conditions; such noise is not harmful and does not affect the life or efficiency of the brakes. After frequent hard use of the brakes, it is beneficial to the durability of the discs and pads if the brakes are allowed to cool down before the vehicle is parked.

Allow the brake pads and discs to 'bed in' fully before using the brakes to their full potential. Pedal effort will reduce as the brakes are bedded in and as they are warmed from cold to normal working temperature, also see page 169.

STARTING AND DRIVING

Anti-Lock Braking System

The Anti-lock Braking System (ABS) reduces the risk of any of the wheels to lock up during braking, ensuring the vehicle can still be steered.

ABS is especially beneficial when braking on slippery road surfaces and in bad driving conditions, but it is important to realise that the ABS cannot increase the friction level at the road surface, it can only make optimum use of the grip available.

The road wheels may appear to lock momentarily which is normal.



NOTE: ABS does not function at speeds below 8 km/h.

When the ABS is activated, a 'pulsing' sensation at the brake pedal will be felt and a clicking from the control solenoids may be heard, indicating that maximum braking is occurring and that the driving style should be modified to suit the road conditions. Also see emergency brake light information on page 114.



WARNING: The benefits that ABS can provide should not encourage you to take more risks with your safety. ABS will not prevent a skid caused by abrupt steering movements or attempting to corner too quickly. ABS does not avoid the risk of an accident due to inappropriate speed. The driver is always responsible for the judgement of safe speed.



WARNING: Always maintain a safe distance from other vehicles relative to the road surface and weather conditions.

On surfaces, such as gravel or snow, a vehicle with ABS may need a longer stopping distance. Allow a greater following distance in these conditions.



The amber warning symbol in the driver's display should illuminate for about 3 seconds following ignition switch on and then extinguish. If the symbol remains illuminated, or comes on whilst driving, an ABS fault has been detected and it is not operating.

The braking system will continue to operate normally, but without ABS operating, braking distances may increase. The vehicle may continue to be driven with appropriate care and anticipation but contact your Lotus Retailer at the earliest opportunity.

The ABS braking system is calibrated for the tyre and wheel size(s) recommended for the vehicle. If incorrect wheels or tyres are fitted, the ABS braking module may receive incorrect information from its sensors resulting in reduced ABS performance.



WARNING: Only fit wheels and tyres of the correct sizes recommended for this vehicle.

Hydraulic Brake Assist

Hydraulic Brake Assist detects an emergency situation by measuring the braking reaction and brake pressure build-up. In case of insufficient brake pressure, the HBA system increases braking force (up to the force until the ABS system is engaged), to ensure the shortest stopping distance possible.

Traction Control System

The traction control system detects any excessive amount of wheelspin from the rear wheels. The system will reduce the engine power output and apply braking to the spinning wheel until grip is restored.



If this indicator symbol is flashing in the driver display when a rear wheel is spinning excessively, then traction control intervention is taking place and the driving style should be modified accordingly.

Electronic Stability Control

Electronic Stability Control (ESC), operating as part of the traction control system, enhances vehicle stability in extreme manoeuvres such as accident avoidance attempts or misjudged cornering demands at which time engine power output is reduced and braking to individual wheels is applied.



If this symbol is flashing in the driver's display whilst driving, then ESC intervention is taking place, indicating that the vehicle's tractive limit has been reached and that driving style should be modified.

ESC is a supplementary driver support function intended to aid the driver, but it cannot be guaranteed to operate fully in every traffic, weather and road condition.



WARNING: Even with these safety systems fitted, do not take any risks and stay alert when driving. The driver is responsible at all times for maintaining appropriate road speed conditions, making any necessary allowances for increased stopping distances.



The symbol illuminates continuously accompanied by a message in the driver's display if a fault has been detected with the ESC system.



If ESC is manually turned off then this symbol is illuminated in the driver's display, see page 165 for further information.



WARNING: Lotus recommends that ESC should always be active when driving on public roads in normal conditions.

Sport Mode

With sport mode selected there is a reduction in ESC settings, allowing increased power-induced wheel slippage thresholds and no throttle reduction on understeer. See page 164.

STARTING AND DRIVING



Electric Parking Brake

The electric parking brake applies the rear brakes to hold and keep the vehicle stationary.

The parking brake switch is located on the outboard side of the steering column.

The parking brake can be manually activated/deactivated with either the engine running or with the vehicle in ignition mode II, see page 149.



NOTE: A motor noise may be heard when the parking brake is applied and may also be heard during the automatic function checking of the parking brake.

Braking force will only be applied to the rear wheels if the parking brake is activated when the vehicle is stationary. Braking force is applied to all four wheels using the hydraulic foot brake circuit if the parking brake is activated when the vehicle is moving but transfers to the rear wheels once almost stationary.

Emergency braking

In an emergency situation, the parking brake can be activated when the vehicle is moving by pulling and holding the lever on the parking brake switch. Braking is deactivated when the lever is released, or the accelerator pedal depressed.



NOTE: An audible warning sounds when the electronic parking brake is activated at high vehicle speed.



CAUTION: Do not use the electric parking brake for normal braking. Using the electric parking brake repeatedly to slow down the vehicle may cause serious damage to the braking system.



Parking Brake Activation

- Depress the footbrake pedal and ensure the gear shift lever for manual transmission vehicles is put into neutral, or for automatic transmission vehicles, P - Park is selected.
- Pull the lever on the parking brake switch towards you and then release.
- Release the footbrake pedal and ensure that the vehicle is stationary.



This symbol is illuminated in the driver's display when the parking brake is activated.

A fault has occurred if the symbol flashes, read the message in the driver's display.

Automatic Activation

The parking brake is activated automatically when:

- The vehicle is switched off and the setting for automatic activation of the parking brake is selected in the centre display, see page 95.
- When P - Park is selected on a steep hill, (automatic transmission vehicles only).



Parking Brake Deactivation

With the engine running or with the vehicle in ignition mode II:

- Depress the footbrake pedal.
- Push the lever on the parking brake switch forwards and then release.

The parking brake will release and the symbol in the driver display extinguishes.

Automatic Deactivation

Automatic Transmission Vehicles:

- With the engine running, depress the footbrake pedal.
- Select gear D - Drive or R - Reverse.
- Release the footbrake pedal and depress the accelerator pedal.

Manual Transmission Vehicles:

- With the engine running, depress the clutch pedal.
- Select an appropriate gear.
- Release the clutch pedal and depress the accelerator pedal as required to move the vehicle.

The parking brake will release and the symbol in the driver display extinguishes.

STARTING AND DRIVING

Hill Start Assist

The Hill Start Assist System helps prevent the risk of unintended vehicle movement when driving away from an incline.

When stopped on an incline, the Hill Start Assist System will hold the brakes on for a further two seconds after releasing the footbrake. The brakes will automatically release after two seconds or as soon as the vehicle begins to accelerate forward (whichever is the soonest).

Drive Modes

Different drive modes are available to alter the vehicle's powertrain, exhaust and stability characteristics.



NOTE: ABS (Anti-Lock Braking) and HBA (Hydraulic Brake Assist) are retained in any mode selected, see page 160 for further details.

Tour Mode

(Default setting, normal road use)

- Exhaust sound, engine speed range, driveability, ESC and performance are optimised for refined driving.
- For automatic vehicles, gear shift points are optimised to offer the optimum fuel economy.
- 'Tour' layout of information within driver's display screen shown, see page 57.

Sport Mode

(Only for suitable road conditions)

- Engine idle speed from start-up will momentarily flare up (increase) and then return to normal if option is selected prior to engine starting.
- A reduction in ESC settings allow

for increased power-induced wheel slippage thresholds and no throttle reduction on understeer.

- Exhaust sound increased, becoming progressively louder based on engine speed and throttle pedal position.
- Throttle pedal response and maximum continuous engine speed are increased.
- For automatic transmission vehicles, lower gears may be automatically selected for improved engine response.
- 'Sport' layout of information within driver's display screen shown, see page 57.

Track Mode (If Equipped)

(For dry condition track use only)

- Engine idle speed from start-up characteristics carried over from 'Sport' mode.
- Optimised traction and corner exit characteristics with reduced ESC intervention.
- For manual transmission vehicles, engine idle speed raised when engine reaches operating temperature.
- Throttle pedal response and maximum continuous engine speed char-

acteristics carried over from 'Sport' mode setting.

- For automatic transmission vehicles, gear shift points are optimised for performance.

ESC TRACK ESC track status indicator symbol is illuminated in the driver's display.

OFF The ESC status indicator symbol is illuminated in the driver's display.

NOTE: With track mode selected, the speed limiter will automatically cancel if currently active, needing reactivation if required. Other driver support functions may also deactivate and dependent on the option, may not be available to reactivate whilst 'Track' mode is active.

ESC 'Off'
(Track use only)

This can be selected in any drive mode. When selected ESC functions are deactivated.

OFF The ESC status indicator symbol is illuminated in the driver's display.

WARNING: Lotus recommends that ESC should always be active when driving on public roads in normal conditions.

NOTE: The position of information and layout displayed on the driver display will change dependent on the drive mode selected, see page 57.

Default Drive Mode Setting

The drive mode can be set with the vehicle in ignition mode II (active), or with the engine running, but will automatically default to tour mode when the engine is switched off.

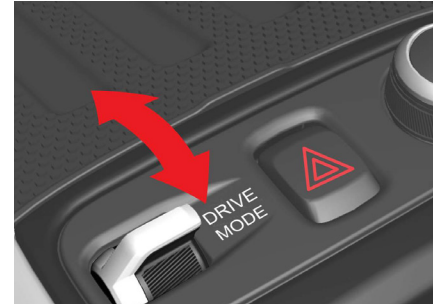

Changing Drive Mode

Move the drive mode switch in the centre console backwards or forwards to change the current drive mode selected.

Switch Movement



Move the switch once to show the active drive mode in the pop-up screen within the centre display.

STARTING AND DRIVING

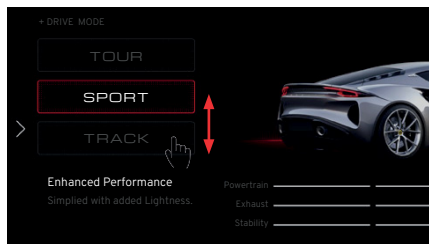

Either move the drive mode switch backwards or forwards again, as required to change to a new mode setting, or press the mode button on the centre display.



NOTE: Selecting sport or track mode from tour mode whilst driving may cause the exhaust sound to increase without additional throttle pedal depression as well as a reduction in the ESC functionality.

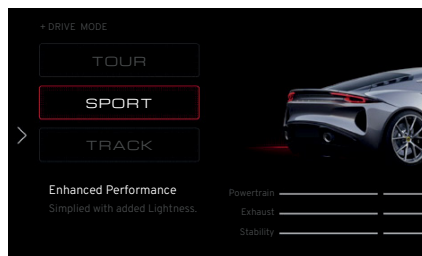

A description of the driving characteristics for the mode selected is shown as well as the level of powertrain, exhaust sound and electronic stability control intervention available, which are represented as illuminated bars at the bottom of the display.

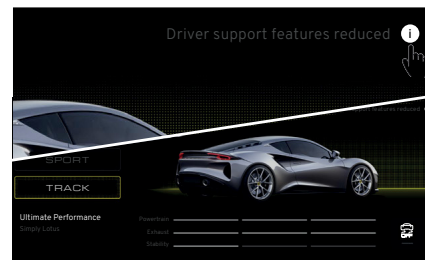

Track Mode Selected

When selected*, tapping the button on the top right-hand side of the display screen will show a message with information on the driver support features that are either not available or automatically deactivated whilst in track mode.

*If equipped.

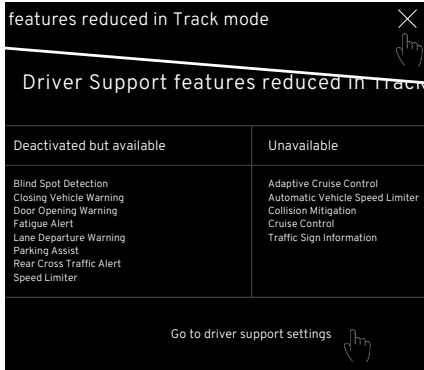

Tap the close button on the top right-hand of the display to return to the previous screen.

Tap 'Go to driver support settings' to display the driver support button within the car settings menu and activate any options as required that were automatically deactivated.



ESC 'Off' Selected

Press and hold the ESC 'Off' button for 2 seconds to activate.



All stability level bars will extinguish indicating that ESC is not available (except for ABS and HBA functions).

The ESC status indicator symbol is illuminated in the driver's display.

The green indicator light below the ESC 'Off' button in the central display is extinguished.

A short press of the ESC button will return the ESC functionality to the appropriate level for the drive mode selected and a message 'Driver Support Features Restored' is shown at the top of the display.

The green indicator light below the ESC 'Off' button in the central display is re-illuminated.

WARNING: If ESC 'Off' is selected whilst driving there will be an immediate reduction in the ESC functionality and a potential risk of vehicle instability. Only select this option if it is safe to do so.

WARNING: Lotus recommends that ESC should always be active when driving on public roads in normal conditions.

RUNNING-IN

Running-In

It is important during the vehicle's early life or if any of the components listed have been replaced to observe the following running-in instructions.

Engine

- For the first 1,600 km, only use moderate throttle openings (about half of the available accelerator pedal travel) and do not run the engine continuously at engine speeds over 4,000 rpm.
- For automatic transmission models, avoid using kick-down.
- Occasional short bursts at wider throttle and higher engine speed will be beneficial, as will a constantly changing cruising speed and making full use of the gearbox.
- Do not allow the engine to labour, change down and let the engine operate in its natural power band.
- After 1,600 km have been covered, full throttle and/or maximum engine speeds may be used*.

*For track use, refer to page 229.

Brakes

Allow the brakes to bed-in by avoiding needless heavy braking for the first 160 km. Thereafter, the first time the brakes are used aggressively, some loss of brake feel may be evident as the brake pads undergo a final conditioning phase. After the brakes have cooled, full brake performance will be restored.

Tyres

New tyres also require a short 'running-in' period before providing optimum grip.

Stopping the Engine

If possible, after a high speed or high load run, allow the engine to idle for a few minutes before switching off the engine. This will allow engine/fluid temperatures to return to normal. This will benefit the long term durability of the powertrain.



NOTE: Failure to comply with the running-in recommendations could invalidate the terms of the vehicle warranty.

Also see 'Engine Data Recording' on page 15.

FUEL FILLING AND FUEL



Fuel Filler Flap

The fuel filler flap is located on the top of the right-hand side rear wing panel, see page 18.

Opening

It can only be opened with the vehicle unlocked and is opened by pushing and then releasing the rear of the flap.

Closing

Gently press the flap down and then release to close.





Fuel Filling

The Emira uses a capless fuel system, using spring-loaded flaps and seals within the neck of the fuel filler tube to prevent fuel and vapours from escaping.

Using a Filling Station

- With the engine switched off, insert the pump nozzle fully into the neck so that both spring-loaded flaps are open.
- Ensure a suitable grade of fuel is selected, (see page 172), fill to the required quantity or until the auto-shut off mechanism is triggered.

 **WARNING:** Switch off the engine before re-fuelling.

 **WARNING:** Follow all operating and safety instructions displayed at the filling station when refuelling.

 **WARNING:** Petrol and petrol fumes are highly explosive. You can be burned or seriously injured when handling fuel.

 **WARNING:** Before re-fuelling, switch off mobile phones and other electronic equipment, ensure that all cigarettes are extinguished and that no naked flames or other potential ignition sources are present.

 **CAUTION:** Do not attempt to fill the tank to the top of the filler neck, as expansion of the fuel due to temperature change may cause flooding of the fuel tank breather system charcoal canister, or spillage of fuel.

For further information on the fuel level display and fuel tank capacity refer to pages 62 and 233.

FUEL FILLING AND FUEL

Using a Fuel Can

The corrugated flexible fuel tube fitted on most fuel cans can cause damage to the spring-loaded flaps and seals within the fuel filler tube.

It is recommended that a capless fuel filler funnel is inserted into the fuel filler tube, (which is designed to push open both spring-loaded flaps), prior to topping up the fuel tank.

Suitable capless fuel filler funnels can be purchased from most automotive parts stores.

Fuel Requirement

Use only high quality UNLEADED fuel with a minimum octane rating of 95 RON.

Lotus recommends the use of 97 RON unleaded fuel where available.

E5 or E10 petrol used must meet EN228 standard.

The use of good quality fuels containing proper detergent additives is advised for good performance and emission control. The vehicle is fitted with catalytic converters in the exhaust system to reduce the noxious content of the exhaust gases and comply with emission control regulations.

! **CAUTION:** It is essential that ONLY UNLEADED FUEL is used. The effectiveness of the catalytic converters decreases after as little as one full tank of leaded fuel or LRP is used.



Diesel

Lotus vehicles will not operate on diesel fuels.



NOTE: Always ensure that the correct filling station fuel nozzle has been selected before re-fuelling. Costs incurred for fuel system draining and cleaning will not be covered by the vehicle warranty.

HOMELINK®

HOMELINK®

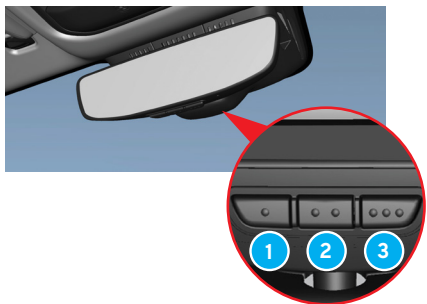

HomeLink®

The HomeLink® system can replace up to 3 remote controlled items such as a garage door, perimeter gate openers and house light switching*.

*If fitted and may not be available in all markets.

If supplied, HomeLink® is fitted within the interior rear view mirror with a control panel located at the base of the mirror and an indicator lamp in the mirror glass.

For information about HomeLink® visit:
homelink.com

 **NOTE:** Put the original remote controls in a safe place for future programming (e.g. when changing to another vehicle or for use in other vehicles)

 **NOTE:** The programming for the buttons should be deleted if you sell your vehicle.

Programming

Follow these instructions to start programming, reset all programming or to reprogram individual buttons.

 **NOTE:** The vehicle must be in ignition mode I or above before HomeLink® can be programmed or used, see page 149.

For faster programming and improved transmission of the radio signal, first fit new batteries in the remote control that will be replaced by HomeLink®

The HomeLink® buttons should be reset before programming, see page 175.

 **WARNING:** The garage door/gate being programmed may operate during programming. Make sure that no persons or animals are near the door/gate when programming. The vehicle should be outside of the garage, clear of the path of travel of the door/gate.

1. Aim the remote control towards the HomeLink® button to be programmed and hold it approximately 2-8 cm from the button. Do not obstruct the indicator lamp on the mirror.

 **NOTE:** If problems occur with the programming, try again whilst increasing the distance between the remote control and HomeLink buttons to between 15-20 cm.

2. Press and hold both the button on the remote control and the required HomeLink button.
3. Do not release the buttons until the indicator lamp has switched from flashing slowly (approximately once per second) to either flashing quickly (approximately 10 times per second) or is constantly illuminated.
 - The indicator lamp constantly illuminated indicates that the programming has finished. Press the programmed button twice to activate.
 - If the indicator lamp flashes quickly then the device to be programmed may have a security function that

requires the device's programming button on its receiver to be manually depressed.

- Test by pressing the programmed button twice to see if the programming was successful.

If you experience problems programming your remote controlled item, contact HomeLink® at HomeLink.com

Reprogramming Individual Buttons

To reprogram an individual button:

- Press and hold the button as required for approximately 20 seconds.
- Once the indicator lamp on mirror starts to flash slowly, programming can continue as normal as shown on page 174.

 **NOTE:** If the button to be reprogrammed is not programmed with a new unit, it will resume the previously saved programming.

Resetting the Buttons

The buttons cannot be reprogrammed individually. It is only possible to reset all of the buttons at the same time.

To reset:

- Press and hold the outer buttons (1 and 3) on the mirror for approximately 10 seconds.
- When the indicator lamp changes from a constant glow and begins to flash, the buttons are reset and can be reprogrammed.

LOTUS E-CALL



Lotus E-Call

Using the SOS alarm button, you can contact a Public Safety Answering Point (PSAP), for help in emergency situations such as illness, injury, or a threat, etc.

NOTE: This service may not be available for all vehicles or in certain markets.

Manual SOS Call

To manually activate the SOS alarm function for emergency assistance, press and hold the SOS button for approximately 2 seconds, you will then be directed to the PSAP.

A 'Calling' notification is shown in the centre display. If the call is not yet

connected it is possible to press the SOS button again within 8 seconds to cancel the call. Once in contact with PSAP, only the PSAP operator can end the call.

If the operator does not get a response from the vehicle occupants, then the appropriate assistance (such as ambulance or police) will be sent to the vehicle's location.

The SOS function has an integrated microphone and speaker in the event of vehicle battery failure.

NOTE: The SOS button should only be used in an emergency situation such as an accident, illness or in the event of a threat to the occupants of the vehicle. Misuse of the SOS button could result in extra charges.

Automatic SOS Call

If an airbag or seatbelt pretensioner is deployed, the SOS alarm automatically activates and calls the PSAP and the appropriate assistance (such as ambulance or police) will be sent to the vehicle's location.

Coverage

Lotus E-Call is available when the ignition is turned ON. The operation of E-Call - SOS Emergency 112 Assistance relies on 2G or 3G cellular coverage and may be affected by signal outages or low signal strength. In these circumstances it may not be possible to establish an E-Call with the Public Safety Answering Point.

In the above circumstances Lotus Cars is not liable for any consequences or losses that occur.



Self-Test and Fault Warnings

The Lotus E-Call system will perform a self-test when the vehicle is in ignition mode II, (see page 149).

During a Self-Test the SOS alarm button's LED status indicator will flash quickly until completion. The LED status indicator will be constantly illuminated if no system faults are present. Faults detected during the self-test or whilst the E-Call is in standby mode will be shown in the driver's display.

LOTUS E-CALL

Status of the Lotus E-Call System

Driver's Display Message		SOS Button Light Flash Rate	Message Description	Action Required
	eCall System Fault Consult Handbook	Once every two seconds for 15 seconds.	Lotus E-Call system is faulty and may not be fully operational.	Contact your Lotus Retailer as soon as possible.
	eCall System Failure Consult Handbook	Four times every second for 15 seconds.	Lotus E-Call system is not operating, cannot support in the event of an accident/emergency.	Contact your Lotus Retailer immediately.
eCall in Progress Consult Handbook		Twice every second.	Lotus E-Call connecting.	No action.
		Constantly illuminated.	Lotus E-Call connected.	No action.
eCall in Standby		Vehicle in ignition mode I, Constantly illuminated.	Lotus E-Call operational with no call in progress or in operator call back mode.	No action.
eCall in Call Back Mode		Vehicle ignition mode 0, Constantly illuminated.	Lotus E-Call in operator call back mode.	No action.
Auto eCall Disablement		Constantly illuminated.	Request deactivation/reactivation of automatic Lotus E-Call function.	Contact your Lotus Retailer immediately.

VEHICLE CARE

VEHICLE CARE

Accessories and Modifications

Lotus Retailers can supply accessories designed and approved by Lotus, supported by the Lotus warranty. Although non-approved Lotus accessories may fit your Lotus, they may not meet Lotus specifications and could adversely affect the safety or handling and stability of the vehicle.

Modifications could make the vehicle unsafe, discuss with your Lotus Retailer before attempting any modifications or fitting accessories.

 **WARNING:** Installing non-approved Lotus accessories, or performing non-approved modifications, can affect the vehicle performance and occupant safety.

 **WARNING:** Lotus does not accept liability for death, personal injury or damage as a result of installing non-approved Lotus accessories or making non-approved modifications.

Vehicle Storage

Fluids

Ensure the engine oil and filter, coolant and brake fluid have all recently been renewed.

Battery

Either leave the battery in the vehicle and connect a battery management (conditioner) type of charger, or remove the battery and trickle charge every two months. Note that with the battery disconnected or removed, the alarm system is de-activated.

Bodywork

Thoroughly clean the inside and outside of the vehicle and allow to dry thoroughly. If necessary, use a pressure washer to remove dirt and salt deposits from the underside, see page 226 for further pressure washer information.

Tyres

Increase the tyre pressures to between 3 -3.5 bar and put a reminder note on the windscreen. If possible, move the vehicle slightly every month to help avoid flat spots on the tyres.

Brakes

Chock the road wheels and leave the parking brake off.

Interior Trim

Unless the garage is equipped with a de-humidifier, the use of drying agents (Silica-Gel) is recommended in vehicles with leather upholstery and in conditions of high humidity.

Air Conditioning

Prior To Storage

The air conditioning system should be in good working order and fully charged.

After Storage

Initial Engine Start

If the vehicle has been stored (and/or the engine not started for a period of 6 months or more), the air conditioning system should be switched on and the engine speed (revs), limited to 2,000 rpm for the first 2-minutes after engine start-up.

This will ensure that the refrigerant gas and oil fully circulate around the air conditioning system, preventing potential damage or premature wear of the air conditioning pump.



NOTE: Air conditioning failures/ damage proven to be caused by insufficient refrigerant oil circulation as a result of excessive engine revving during initial engine start-up after long periods of vehicle storage/inactivity will not be covered by the New Vehicle Warranty.

Car Covers

Using a non-approved Lotus car cover can prevent the battery from being adequately cooled during charging as well as damaging the paint finish. Wash and clean the vehicle and ensure it has fully dried before fitting a Lotus approved cover.

VEHICLE CARE

Owner Maintenance

Performing the simple maintenance checks detailed in this section (daily if covering high mileage or touring) and having your vehicle regularly serviced by your Lotus Retailer will ensure its maximum safety, reliability and longevity.

It is important that the maintenance schedule is followed at the specified time and distance intervals, (see separate booklet).



NOTE: Failure to follow and comply with the maintenance schedule may invalidate the terms of the vehicle warranty.

Contact your Lotus Retailer immediately if you notice a significant or sudden drop in fluid levels or uneven tyre wear.



WARNING: Failure to take corrective action may damage the vehicle and lead to accidents, potentially resulting in serious injury or death.

Track Use

This type of usage requires appropriate driver training and vehicle preparation by a qualified specialist in order to maintain a suitable level of safety above that specified in the maintenance schedule. Vigilance will also be required, including careful inspection of all safety critical components both before and after this type of vehicle usage.



NOTE: Using the vehicle on track or in a competitive manner will cause a greater degree of wear and tear to components than normal road use.

General Safety

Read and follow the precautions listed below for your protection before performing any maintenance checks:

- Vehicle repairs should only be carried out by a suitably qualified technician.
- If the vehicle has been driven recently, do not touch the cooling system components until the vehicle has cooled.
- Beware of hot surfaces in and around the engine bay, including the supercharger casing. You could be seriously burnt by touching a hot engine part.
- Keep clothing, hands, hair, other body parts, loose clothing and tools away from drive belts, pulleys, and fans. Some fans may continue to operate, or start operating, after the motor is switched off.
- The voltages produced with this ignition system can cause serious and potentially fatal injury.
- Never touch any ignition components when the engine is running or being cranked.

- Never work inside the engine compartment when an automatic transmission gear has been selected.
- Do not allow tools or metal parts of the vehicle to contact battery leads or terminals.
- Some fluids (battery acid, coolant, brake fluid, windshield washer additives, etc), used in vehicles are poisonous and should not be inhaled, swallowed, or brought into contact with open wounds. For your safety, always read and follow instructions printed on fluid containers.

 **WARNING:** Failure to follow these precautions can result in serious injury or death.

 **CAUTION:** Failure to follow these precautions can result in damage to the vehicle and or property.

Service Reminder



Book time for maintenance

Based on the mileage and time period since the vehicle's last service, this symbol and message is shown in the driver's display every time the engine is started.



This is a reminder that next service will soon be required. The message displayed changes as the vehicle approaches the due service date interval.

Contact your Lotus Retailer to arrange the required service when this message first appears.

Removing the Message

The message can be removed from the screen by pressing the confirm button on the right-hand steering wheel keypad, see page 77.

Resetting the Service Reminder

- Set the vehicle in ignition mode I (Convenience), see page .
- Press and hold the reset button located on the end of light switch, see page 113.
- With the reset button still pressed, start the engine, see page 150.
- After 10 seconds with the reset button still pressed, the  symbol will flash.
- Release the reset button within 4 seconds of the  symbol beginning to flash.

 **CAUTION:** This reminder should not be reset unless the vehicle has been serviced in accordance with the recommended Lotus maintenance schedule.

VEHICLE CARE

Daily Checks

Check the operation of the:

- Exterior lights.
- Horn.
- Turn signals.
- Windscreen wipers.
- Windscreen washers.
- Seat belts.
- Braking system including parking brake.
- Park Assistance Systems

Also check:

- Warning lamps or alert messages on the instrument panel.
- Fluid deposits underneath the vehicle that may indicate a leak, (water drips from condensation on the air conditioning system are normal).
- The exterior of the vehicle and immediately remove any corrosive substances to prevent damage to the paint (see page 225).

Regular Checks

It is recommended to regularly check, and where necessary top up or adjust the following items:

- Engine oil
- Coolant level.
- Brake fluid level.
- Windscreen washer fluid level.
- Park Assistance System sensors and camera for dirt, snow or ice.

Also check:

- Tyre pressures and condition.
- Operation of the air conditioning.
- Wiper blades.



NOTE: Check these items more frequently if the vehicle is subject to high mileage driving or severe operating conditions.

Front Access Panel



Unlocking/Opening

- From the windscreen lower trim panel, prise off the 3 cover panels covering the front access panel securing screws.
- Using the torx driver supplied within the vehicle tool kit, unscrew and remove the 3 securing screws.
- Retain the screws in a safe place for refitment.



- Lift the rear of the access panel fully upwards, (do not overextend the panel travel).
- Pull the access panel supporting stay out of the holder located at the front of the heater box housing panel.
- Fit the end of the stay into the slotted plate located on the underside of the access panel.

Closing/Locking

- Lift the access panel slightly and remove the end of the support stay from the slotted plate.
- Refit the stay into the holder.
- Keeping fingers clear of entrapment and ensuring that there are no obstructions, lower the access panel and align the holes within retaining brackets with the body panel screw threads.
- Refit all 3 securing screws by hand until they are hand tight.
- Using the torx driver supplied with the vehicle tool kit, tighten all 3 screws to 10Nm.
- Refit the plastic covers into place in the windscreen lower panel.



WARNING: To prevent the risk of the front access panel moving or becoming unstable, never drive the vehicle unless all three front access panel securing screws are fitted and tightened correctly as described in this procedure.

VEHICLE CARE

! **CAUTION:** Failure to follow this procedure may result in damage to your vehicle.

The front access panel is only intended to provide access for vehicle servicing, it is not intended for storage usage.

! **CAUTION:** Attempting to store items, however small within the front service compartment may potentially cause damage to components within the service compartment as well as the body panels. Damage caused by this will not be covered by the vehicle warranty.

Engine Compartment

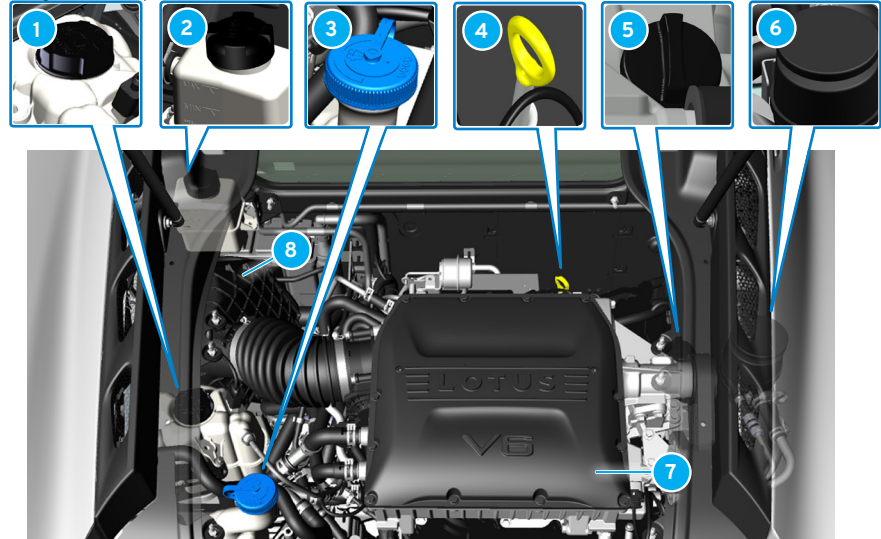

Overview

Engine compartment covers removed for clarity.

- | | | | |
|---|---------------------------------------|---|---------------------------------|
| 1 | Engine coolant expansion tank. | 5 | Engine oil filler cap. |
| 2 | Charge cooler coolant expansion tank. | 6 | Power steering fluid reservoir. |
| 3 | Washer fluid reservoir. | 7 | Supercharger casing. |
| 4 | Engine oil dipstick. | 8 | Air filter. |

Engine Compartment Panels

Engine cover panel removal is not necessary when checking the engine oil and windscreen washer fluid levels, see pages 188 and 189.

Panel Removal

Always turn off the engine before attempting to remove the engine bay panels, never attempt to remove the engine bay panels whilst the engine is running.

⚠ WARNING: Failure to follow this instruction can result in serious injury or death.

1. Lift the tailgate, see page 46.
2. Using light hand pressure, lift up the inner sides of the front panel to release the underside fixings from the bodysides.
3. Remove the front panel by pulling it rearwards to release the forward fixings from the bulkhead panel.
4. Using light hand pressure, lift up the inner sides of the rear panel to release the four underside fixings from the bodysides.

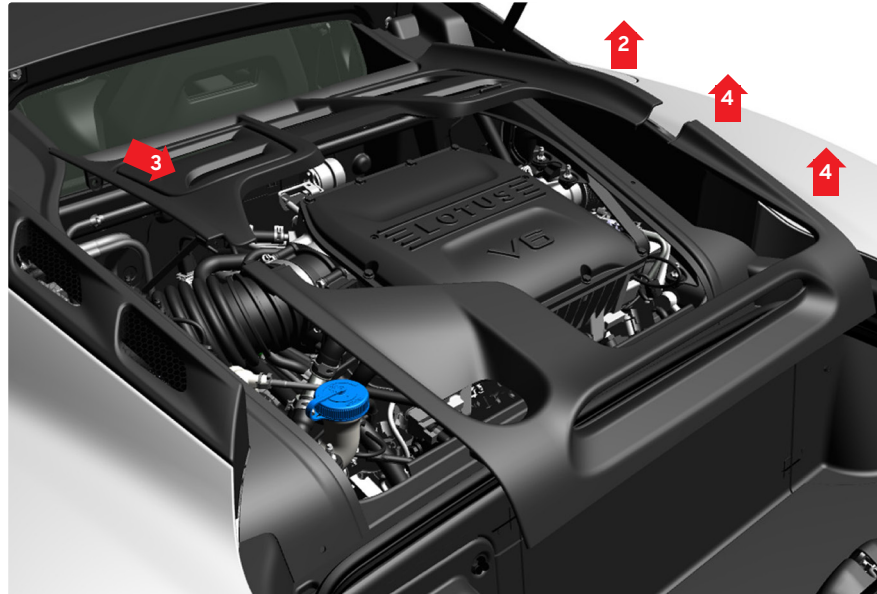

📖 NOTE: To prevent accidental damage to the panels, place them in a safe area with the fixings facing downwards.

Refit the panels in the reverse order of removal.

Before closing the tailgate, check that all of the engine compartment panels have been fitted correctly and are secure.

Also ensure that there are no obstructions that would prevent the tailgate from closing properly and that no items, such as gloves, tools or rags etc, have been left in the engine bay.

VEHICLE CARE

 **WARNING:** Failure to follow these instructions may cause a fire and personal injury.

Engine Oil Level Check

The engine oil level should be checked regularly, e.g., every 1,600 km, or sooner if the vehicle has been driven under severe conditions, see page 229.

Before checking the engine oil level, ensure the vehicle is parked on a level surface and if necessary, wait for at least 15 minutes after the engine is switched off if the engine is still warm.

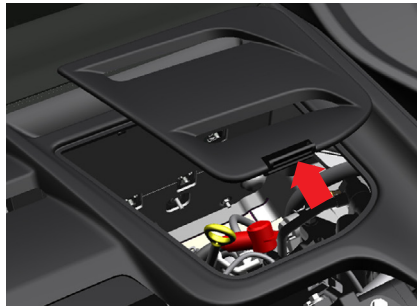

- Lift the tailgate, see page 46.
- Release the fixing clip on the dipstick access panel located on the right hand side of the front engine compartment panel.
- Lift up the panel and remove from the engine bay.

- The dipstick handle is yellow. If access to the dipstick is required when the engine is hot, be aware of hot surfaces in the engine bay and wear appropriate protective clothing to prevent burn injuries.
- Withdraw the dipstick and wipe with a paper towel.
- Replace the dipstick into the dipstick tube.
- Withdraw the dipstick again to inspect the oil level.

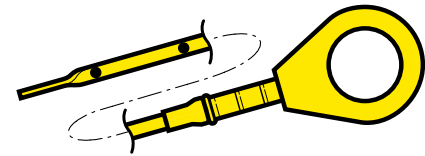



The level should be between the two dots on the lower end of the dipstick.

For optimum engine protection, maintain the level towards the top mark, and do not allow to fall below the mid-point.

The difference between the high and low dipstick marks is equivalent to approximately 1.5 litres of oil.

- If topping up is necessary, the front engine compartment panel must be removed, see page 187.
- Unscrew the oil filler cap counter-clockwise, see item 5 on page 186, then add a suitable quantity of the recommended engine oil (see 'Recommended Lubricants' section), taking care not to spill any oil onto the engine or electrical components; use a funnel if necessary and clean up any spillage.
- Allow several minutes for the oil to drain through to the sump before re-checking the oil level.
- Refit the filler cap, turning clockwise until secure.

 **WARNING:** Engine oil is hazardous to your health and may be fatal if swallowed.

 **WARNING:** Prolonged and repeated contact with used engine oil may cause serious skin disorders, including dermatitis and cancer.

 **WARNING:** Use protective gloves to avoid contact with skin as far as possible and wash skin thoroughly after any contact.

 **WARNING:** Keep engine oil out of the reach of children.



Windscreen Washer Reservoir

The blue coloured reservoir filler cap for the windscreen washer reservoir is located to the left-hand side of the engine compartment.

Topping Up

1. Lift the tailgate, see page 46.
2. Unscrew the filler cap counter-clockwise to open.
3. Fill the reservoir with clean water and a good quality windscreen washer fluid (see 'Technical Data' section), until the fluid level is visible just below the filler neck.
4. Wipe up any spills immediately and wash the affected area with water.
5. Screw the filler cap clockwise onto the reservoir until secure.

VEHICLE CARE

 **WARNING:** Windscreen washer fluid can cause skin and eye irritation. Read and follow any instructions or warnings provided by the windscreen washer fluid manufacturer.

 **WARNING:** A good quality product should be used and mixed as per the manufacturers recommendations as an insufficient concentration may result in fluid freezing inside the pump, reservoir and hoses.

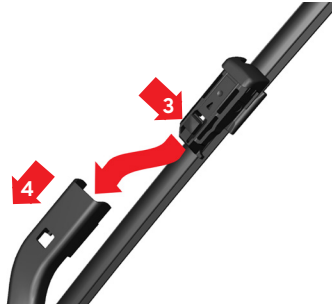

Wiper Blade Renewal

1. Fold the wiper arms outwards.
2. Press the button on the wiper blade mounting.
3. Pull the wiper blade out of the wiper arm.
4. Slide in the new wiper blade until a “click” is heard.
5. Check that the blade is firmly installed.
6. Fold the wiper arm back onto the windscreen.

 **WARNING:** Only change a wiper blade when the vehicle’s ignition is inactive (0) or in convenience mode (1) and the vehicle is stationary, see page 149 for further information.

 **CAUTION:** Do not fold back the wiper arms if a wiper blade is not fitted. This may damage the windscreen.

 **NOTE:** The driver and passenger side wiper blades are different sizes.

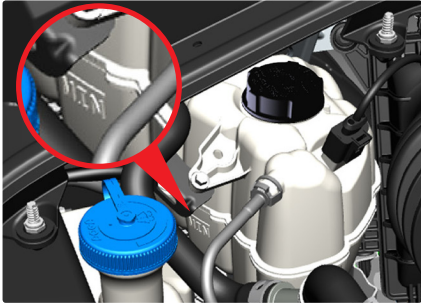

Engine Coolant

To check the engine coolant level, the engine compartment panels must first be removed, see page 187.

The engine cooling system expansion tank is positioned on the left-hand side of the engine bay, identified by its black filler cap.

Under normal circumstances it should not be necessary to add any coolant to the system.

Check when the engine is fully COLD and only when the vehicle is on a completely level surface, without disturbing the pressure cap, check the level of coolant in the expansion tank is above the 'MIN' mark.

Topping up

Ensure that the coolant is fully cold before slowly unscrewing the filler cap counter-clockwise, allowing any remaining pressure to escape before finally removing the cap.

⚠ WARNING: Do NOT attempt to remove the pressure cap from the expansion tank when the engine is warm as serious scalding could result from boiling water and/or steam.

⚠ WARNING: Coolant is hazardous to your health and to animals and may be fatal if swallowed.

⚠ WARNING: Keep coolant out of reach of children.

⚠ WARNING: Clean up spilled coolant and do not leave in open containers.

VEHICLE CARE

Top up the expansion tank to the 'MIN' mark, refit the cap and turn clockwise until the tab on the cap engages a detent and an audible click can be heard.

NOTE: To maintain protection from freezing damage and metal corrosion, use only an approved coolant mixture (see 'Recommended Lubricants' section for specification).

CAUTION: No other type of coolant should be mixed with the coolant type specified in the recommended lubricants section of this handbook, or degradation of the cooling system may result.

CAUTION: Using an incorrect coolant mixture may result in expensive damage to the engine and/or other components caused by overheating, freezing or corrosive effects. Such damage is not covered by the Vehicle Warranty.

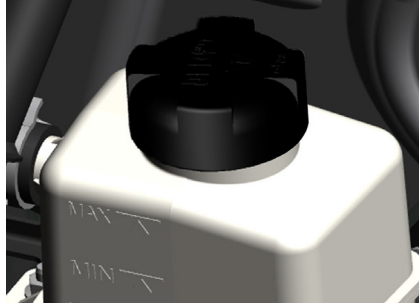

Charge Cooler Expansion Tank

The charge cooler system coolant circuit has a coolant reservoir mounted on the forward left hand-side of the engine bay, see item 1 on page 186.

Under normal circumstances it should not be necessary to add any coolant.

It is recommended that this operation is only carried out by your authorised Lotus Retailer as part of the recommended service schedule.



Steering Fluid Reservoir

The power assisted steering fluid reservoir is located at the right hand corner of the engine bay, see item 6 on page 186.

Under normal circumstances it should not be necessary to add any fluid.

Because inspection of the fluid level requires the removal of the right hand rear wheelarch liner, it is recommended that this operation is only carried out by your authorised Lotus Retailer as part of the recommended service schedule.

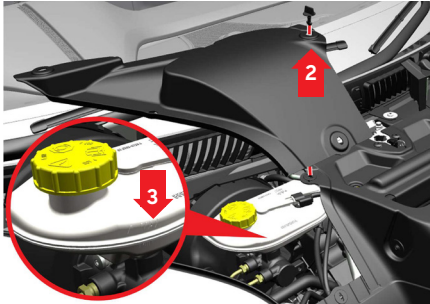

Brake/Clutch Fluid Level Check

(⚠) If the brake fluid level becomes low a warning symbol and message will be displayed in the driver's display screen.

If the symbol illuminates whilst driving, stop the vehicle immediately as a dangerously low level of brake fluid in the master cylinder reservoir has been detected. The vehicle should not be driven until the fault has been identified and rectified.

Your Lotus Retailer will check the brake fluid level as well as change the brake fluid at the regularly scheduled maintenance intervals.

To check the fluid level yourself, ensure the vehicle is parked on level ground.

1. Open the front access panel, see page 185.
2. Remove the 5 quarter turn fixings securing the brake fluid reservoir panel (located on the driver's side of the vehicle) and remove the panel.
3. Without removing the reservoir cap, check that the fluid level is in between the 'MAX' and 'MIN' marks on the reservoir body.

NOTE: The brake fluid level will drop gradually from the 'MAX' mark as the brake pads wear, but if the level drops below the 'MIN' mark, then contact your Lotus Retailer to investigate without delay.

WARNING: If you notice increased movement of the brake pedal or a significant loss of brake fluid, then contact your Lotus Retailer immediately. Driving under these conditions could result in increased stopping distances or complete brake failure.

Topping Up

These instructions are provided for reference only and under normal circumstances, there is no requirement for routine 'topping up'.

1. Clean around it to prevent dirt ingress into the reservoir.
2. Unscrew the reservoir cap counter-clockwise.
3. Top up the reservoir brake fluid level to the 'MAX' mark using a suitable brake fluid, see page 232, do not overfill.
4. Screw the reservoir cap clockwise onto the reservoir until secure.

WARNING: Use only new brake fluid from a sealed container. Do not use any fluid which has been exposed to the atmosphere for more than a brief period, or any fluid suspected of being wet, dirty or contaminated. Do not overfill. Replace the cap securely.

VEHICLE CARE



WARNING: Brake fluid is hazardous to health and may be fatal if swallowed. Keep out of children's reach. In the event of consumption, seek medical attention immediately.



CAUTION: Spilled brake fluid can seriously damage the vehicle paintwork and some plastic components. Take suitable precautions to protect the paintwork from contamination and in case of spillage, do not wipe, but thoroughly rinse the affected area with water immediately.

Tyres

The wheel and tyre sizes on the vehicle are different front and rear, interchanging of wheels and tyres between axles is not permissible.

⚠ WARNING: Failure to adhere to this requirement will adversely affect the handling of the car and may result in an accident.

Tyre Inspection

The tyres should be regularly inspected for signs of cuts, abrasions, bulges, other damage and for any uneven tread wear patterns. Uneven tread wear may indicate that the suspension geometry or dampers require attention from your Lotus Retailer.

When assessing tyre condition and serviceability, replace tyres if any doubt exists, or if the legal tread depth limits are approached.

⚠ WARNING: Damaged, poorly maintained or improperly used tyres are dangerous and may cause an accident.

Wear Indicators

Wear indicators are moulded into the bottom of the tread grooves at intervals around the tyre, indicated by small pointers on the outer tread blocks. The tyres should be replaced before wearing down to this minimum legal tread depth.

Worn tyres with a low tread depth are more likely to hydroplane in wet conditions and should not be used.

Recommended Tyre Pressures

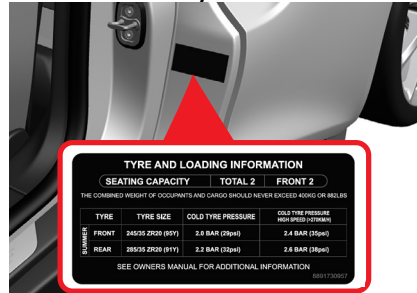

The cold tyre pressures should be checked every week, or every 1,600km, whichever is the sooner and adjustments made as necessary.

A decal on the driver's side door pillar

displays the recommended pressures for factory fitted tyres. The 'Technical Data' section at the back of this handbook also lists the recommended tyre pressures.

Cold Tyres

Check/adjust tyre pressures only when the tyres are cold (i.e. the vehicle has been stationary for a minimum of 3 hours or has been driven less than 1 mile/kilometre), as the pressures may increase when the tyres are warmed to normal running temperature.

Tyre Pressures For Track Use

For track use, tyre pressures should be checked and adjusted only once the tires are warm which can be achieved by performing approximately 3 moderate speed laps of the track circuit.

After rest intervals the pressures should be checked and adjusted to the correct inflation pressures, then warmed up again as described above prior to resetting them for track use. Once track use is completed, the tyres should be given sufficient time to cool down before they are checked

VEHICLE CARE

and adjusted to the correct inflation pressures for road use. Refer to the 'Technical Data' section for further tyre pressure information.

Due to the severity of tyre operating conditions, extra vigilance is required for vehicles used on a race track or in a competitive manner. Careful inspections must be carried out before and after each session.

 **NOTE:** Lotus does not endorse such use of the Emira - refer to the Warranty Booklet section 2 'Intended Purpose'.

Michelin Pilot Sport Cup 2 Tyres

IMPORTANT: If fitted, the Michelin Pilot Sport Cup 2 tyre provides outstanding grip and traction when used in dry conditions above 7 degrees Celsius. The lower tread profile does present a greater risk of aquaplaning on wet roads and grip can be reduced when driven in cold weather. Drivers should exercise caution and drive in a style according to the road conditions.

Adjusting Tyre Pressures

 **NOTE:** To avoid incorrect tyre pressures, the pressures should be checked on cold tyres as previously described in this section.

1. Remove the dust cap from the valve on one tyre and then press the tyre pressure gauge firmly down onto the valve.
2. Inflate or deflate the tyre to the correct pressure, see the decal on the driver's side door pillar showing the recommended pressure for factory fitted tyres.
3. Refit the dust cap.
4. Check the tyre for any cuts, imbedded objects (such as nails that could cause a puncture or leakage), abrasions, bulges, other damage and for any uneven tread wear patterns.
5. Repeat this procedure for all tyres.
6. Refer to page 202, 'Calibrating tyre Pressure Monitoring System'.

 **WARNING:** Over-inflated tyres are more likely to be cut, punctured or broken by a sudden impact.

 **WARNING:** Improperly inflated or worn tyres are more likely to aquaplane in wet conditions.

 **WARNING:** Over or under-inflated tyres can overheat, resulting in a blowout which may cause a serious accident.

 **NOTE:** Always replace the tyre valve dust cap to prevent the ingress of dirt and moisture into the valve, which could cause leakage.

 **NOTE:** Only plastic dust caps should be fitted. Fitting a metal cap may cause corrosion making it difficult to unscrew or even cause valve damage.

Tyre Replacement

When replacing tyres, always use the size and type of tyres recommended in the 'Technical Data' section of this handbook, (see page 235), or consult your Lotus Retailer to check the current Lotus specification and recommendations.

⚠ WARNING: Using the incorrect tyres can affect the vehicle's handling and stability.

📖 NOTE: Some tread patterns are asymmetric, such that the tyres must be fitted to the wheels the correct way round. Refer to the 'side facing inwards' or 'side facing outwards' marking on the tyre sidewall. In addition, some tread patterns are directional, in which case a direction of normal rotation arrow will be included in the tyre sidewall markings.

Winter Tyres

If the car is to be used in winter or in cold conditions, or driven on snow covered roads, it is recommended to fit a car set of winter tyres developed specifically for such conditions. Lotus approves the use of winter tyres in sizes as specified in the 'Technical Data' section, (see page 235). The specific tyres recommended are available to order from your Lotus Retailer.

Snow Chains

Snow chains should only be fitted on the rear wheels in conjunction with winter tyres. Follow the fitting and tensioning instructions supplied with the chains. The chains should be removed as soon as road conditions allow. See page 235.

📖 NOTE: Vehicle handling can be adversely affected when driving with snow chains.

📖 NOTE: Using snow chains may be prohibited in certain markets. Always check local regulations/laws before fitting snow chains.

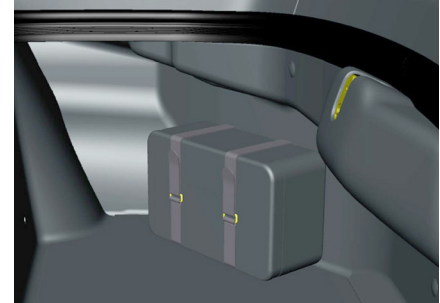

Tyre Inflator Kit

The kit contains an electrical pump and tyre sealant bottle which is secured with straps to the right-hand side of the rear luggage compartment. Minor damage to the tread of the tyre can be repaired using the tyre repair kit.

📖 NOTE: Do not remove foreign bodies from the tyre.

📖 NOTE: Extensive damage to the tread or any damage to the tyre sidewall or wheel cannot be repaired using the repair kit.

⚠ CAUTION: If possible, avoid driving on a deflated tyre to avoid irreparable damage to the tyre.

VEHICLE CARE

NOTE: Use of the aerosol is not a permanent repair but will allow the car to be driven to the nearest tyre depot. At the earliest opportunity, the tyre should be repaired or replaced. Until then the car should be driven only in a moderate manner, not exceeding 80 km/h as steering and handling may be affected.

Using Tyre Inflator Kit

1. Park on a level, stable surface away from moving traffic.
2. Switch on the hazard warning lights and if necessary, set up a warning triangle at a sufficient distance to the rear. Comply with any local legislation required.
3. All occupants must get out of the car and must move to a safe place away from any oncoming traffic.
4. Apply the vehicle handbrake and engage first or reverse gear or P - Park.
5. Remove the tyre inflator kit box from the luggage compartment.
6. Remove the compressor and sealant bottle from the kit box.



7. Remove the electrical connector/cable from the compressor stowage compartment and the transparent airline hose from the tyre sealant bottle.
8. Wear the protective gloves provided in the kit.



9. Press the tyre sealant bottle firmly into the port in the compressor.

10. Ensure the  on-off button on the compressor is set to off.



11. Position the compressor near the tyre, ensuring the sealant bottle is upright.
12. Remove the valve cap from punctured tyre.
13. Screw the transparent airline hose to the tyre valve.
14. Connect the compressor connector to the 12V auxiliary power socket, see page 129.

NOTE: It is recommended to run the engine to avoid discharging the battery.



15. Press the  on-off button to start the compressor.

Correct Tyre Pressure Not Achieved
See page 200.

Correct Tyre Pressure Achieved

If the tyre has reached the correct pressure:

16. Switch off the compressor using the  on-off button, disconnect the sealant tube from the tyre valve, remove the speed sticker from the side of the sealant canister and put in the vehicle cabin where it can be easily seen.

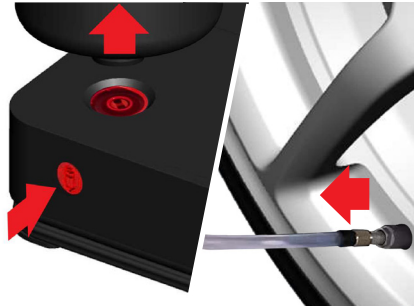

17. Disconnect the compressor connector from the 12V auxiliary power socket, press the button on the side of the compressor to detach the tyre sealant bottle and refit the tyre valve cap.

18. Refit the compressor and tyre sealant bottle into the kit box and refit securely back into place within the luggage compartment.

19. You can continue driving, but do not exceed 80 km/h. Do not accelerate or brake suddenly.

20. After driving for about 8 km, stop the vehicle in a safe place and engage the handbrake.



21. Take out the kit and reconnect the compressors electrical connector into the 12V power socket in the vehicle, ensuring that the on-off button is set to off.

22. Remove the cap from the repaired tyre valve, take out the black inflation tube from around the compressor base and firmly tighten the tube connector into the valve.

23. Check the pressure gauge for the correct tyre pressure reading.

VEHICLE CARE

Pressure 1.8 bar / 26 psi or Above

24. Switch on the compressor using the  on-off button and inflate the tyre to the correct pressure.



25. Release excessive tyre pressure by pressing the  button over the pressure indicator.



26. Disconnect the kit as described in steps 17 – 18.

27. Drive carefully and take the vehicle to a Lotus Retailer or tyre specialist as soon as possible.

Pressure Below 1.8 bar / 26 psi

THE TYRE IS TOO DAMAGED TO REPAIR. Disconnect the kit as described in steps 16 – 18 and then call for roadside assistance, see page 18.

Correct Tyre Pressure Not Achieved

– If, after 15 minutes from the compressor being switched on, the pressure gauge still shows a pressure of less than 1.8 bar / 26 psi, switch off the compressor using the  on-off button, disconnect the sealant tube from the tyre valve and refit the tyre valve cap.

– Move the vehicle so that the tyre rotates approximately 5 turns to ensure the sealant is distributed inside it.

– Stop the vehicle in a safe place and repeat steps 10 – 15 shown on page 198 until the tyre reaches the correct pressure.

– Follow steps 16 – 27 on page 199 if the tyre has reached the correct pressure after 15 minutes.

If, after 15 minutes from the compressor being switched on, the pressure gauge still shows a pressure of less than 1.8 bar / 26 psi THE TYRE IS TOO DAMAGED TO REPAIR. Disconnect the kit as described in steps 16 – 18 shown on page 199 and then call for roadside assistance, see page 18.

 **NOTE:** The tyre sealant bottle displays an expiry date. After the date shown, it should be renewed.

 **NOTE:** Pay attention to storage information on sealant bottle.

 **NOTE:** When replacing the used tyre sealant bottle ensure to comply with any local legislation required.

 **NOTE:** The compressor and sealant can be used from approximately. -40 °C - +50 °C.

 **NOTE:** The electronic pressure sensor mounted inside the tyre and integral with the tyre valve, could be obstructed by the sealant and should be renewed.



Tyre Pressure Monitoring System

The tyre pressure monitoring system constantly monitors the tyre pressure in each wheel. If selected as a menu option, current pressure information can be shown in the instrument panel, see page 77.

NOTE: The tyre pressure monitoring system is not a substitute for proper tyre maintenance and it is the driver's responsibility to maintain correct tyre pressures, even if under-inflation has not reached the level to trigger illumination of the low tyre warning symbol.

The  tyre pressure monitoring warning symbol will illuminate to warn if one or more of the tyres become significantly under-inflated and a warning message is also shown in the driver's display screen, see page 77 for further information.

When the  warning symbol illuminates, you should stop and check your tyres as soon as possible and inflate them to the correct pressures, see page 196.

WARNING: Driving with under-inflated tyres could cause the tyres to overheat and can lead to tyre failure and may affect the vehicle's handling and stopping ability.

WARNING: Under-inflation also reduces tyre tread life and may affect the vehicle's handling and stopping ability.

WARNING: Damage to a tyre will not be registered by the tyre pressure monitoring system. Regularly check the tyre condition and pressures, especially when driven on a track. Failure to do so may lead to serious injury or death.

VEHICLE CARE

System Malfunction

If a malfunction is detected within the tyre pressure monitoring system, the  warning symbol will flash for approximately one minute and then remain continuously illuminated and a warning message shown in the driver's display screen.

When the malfunction indicator is illuminated, the system may not be able to detect or signal low tyre pressure as intended.

Malfunctions may occur for a variety of reasons, including the installation of replacement or alternate tyres or wheels on the vehicle that prevent the system from functioning properly.

Always check the  warning symbol after replacing one or more tyres or wheels on your vehicle to ensure that the replacement of alternate tyres and wheels allow the tyre pressure monitoring system to continue to function properly.

TPMS Sensor Renewal Intervals

The sensors are powered by integral batteries, with an average service life of 5 years. It is recommended to renew all pressure sensors at this time interval.

Calibrating Tyre Pressure Monitoring Sensor

After the fitment of a new sensor or wheel removal/refitment the tyre pressure monitoring symbol will be illuminated in the driver display.

Driving the vehicle with the tyres at the correct pressures for a short period of time will allow the sensor to calibrate to the tyre pressure monitoring system and the symbol will extinguish.

A guided routine to calibrate the sensor pressure is available from the app launcher screen in the central display, see page 98. Tap on the  button and follow the onscreen instructions.

Wheels

Ensure that only original equipment, or Lotus approved wheel, tyre and wheel bolt combinations are fitted.

After striking a pothole or kerb, the wheels should be removed and the wheel and tyre thoroughly inspected for damage. If necessary, renew the wheel and/or tyre.

Safety should always be the first consideration and new parts fitted in any cases of doubt.



WARNING: Using incorrect, or non-approved replacement wheels or wheel locks could be dangerous. It could affect the braking and handling of the vehicle, or cause tyre deflation and result in an accident.



WARNING: Putting a used wheel on a vehicle is dangerous. It may have structural damage which cannot be seen and lead to breakage causing an accident.

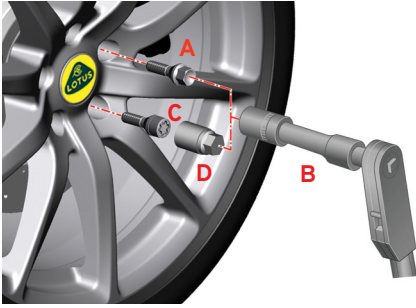

Wheel Changing

For advice and information on lifting the vehicle, refer to 'Raising the Vehicle' on page 205.

Wheel Removal

Before carrying out this procedure:

1. Park on a level, stable non-slippery surface away from moving traffic.
2. Switch on the hazard warning lights and if necessary, set up a warning triangle at a sufficient distance to the rear. Comply with any local legislation required.
3. All occupants must get out of the car and must move to a safe place away from any oncoming traffic.

4. Apply the vehicle handbrake and engage first or reverse gear or P - Park.
5. Securely chock all wheels not to be lifted.
6. Loosen the wheel bolts (A) ¼ turn counter-clockwise using a 17 mm socket and suitable torque wrench (B) (not supplied), but do NOT remove the wheel bolts at this stage.

! **CAUTION:** Do not use hammer action air tools on locking wheel bolts (D, if fitted)*, use only manual tools.

*Optional locking wheel bolts (C), may be fitted requiring the corresponding coded socket wrench (D), supplied with the locking bolts to release them.

Rotate the coded socket until fully engaged with the bolt head and take care to maintain the extension tool perpendicular to the wheel face before applying release torque.



7. Position a suitable jack at the rear lifting point identified by a blue sticker, see page 205, 'Raising the Vehicle'. This will raise both wheels on that side of the vehicle.

! **WARNING:** Use a jack designed for the vehicle when changing wheels.

! **WARNING:** Never work or reach under the vehicle with a part of your body when it is raised on a jack.

! **CAUTION:** Use only those lifting points identified. Jacking on any part of the body, or with a jack improperly positioned, may damage the chassis or body structure.

VEHICLE CARE

8. follow any instructions provided with the jack.
9. Raise the vehicle off the ground.
10. Remove the wheel bolts and remove the wheel.

Wheel Fitment

1. Ensure the contact surfaces of the wheel to be fitted and wheel hub are clean, if not, clean as necessary.
1. Position the wheel on the hub.
2. Screw in at least 2 of the vehicle's wheel bolts at opposite points to retain the wheel in position onto the hub assembly.
3. Screw in the remaining 3 wheel bolts.



4. Tighten all 5 wheel bolts in a cross-wise pattern using the standard extension and (and coded wheel bolt adaptor if locking wheel bolts are fitted).
5. Following manufacturers' instructions, release the jack and lower the vehicle to the ground.
6. Fully tighten the bolts to a torque of 105 Nm.

 **NOTE:** Do not use any lubricants on the threads of the wheel bolts.

 **WARNING:** Dirt/corrosion on a wheel or hub mounting, oil or grease on the wheel bolts/hub threads, using incorrect wheel bolts, or the wrong tightening torque could cause the bolts to loosen resulting in a wheel coming off.

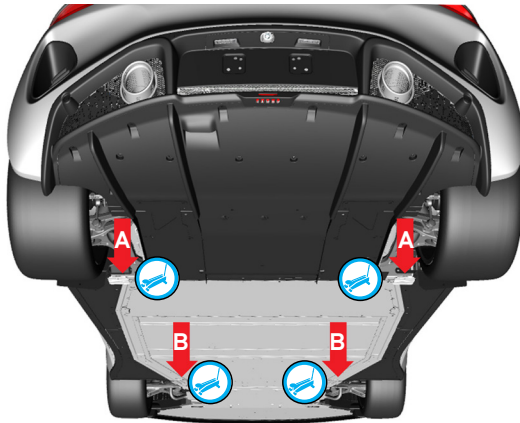

Jacking

A Points to lift both wheels on one side.

B Points to lift front of vehicle on one side.



2-Post Lift

use all 4 **A & B** lifting points.

Raising the Vehicle

Only position the jack or ramp lifting pads under the  areas shown.

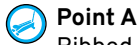

Point A

Ribbed alloy pad beneath the rear end of the chassis, forward of the rear wheelarch.



Point B

Ribbed alloy pad beneath the front end of the chassis, inboard/rear of the front wheelarch.



WARNING: Use only those lifting points identified above. Lifting on any part of the body, or with a jack improperly positioned, may jeopardise safety.



WARNING: Using a lifting jack can be dangerous. If the car falls off the jack, you or others could be seriously injured or killed. NEVER get under a car when it is supported only by a jack.



CAUTION: Use only those lifting points identified. Lifting on any part of the body, or with a jack improperly positioned, may damage the chassis or body structure.

VEHICLE CARE

Battery



Battery Access

The battery is located at the left-hand side of the rear luggage compartment. To access the battery, open the tailgate, (see page 46), then release the thumb screws on the battery cover and remove.

WARNING: Batteries contain sulphuric acid avoid contact with skin, eyes, mouth or clothing. If in contact with skin or eyes; flush with large amounts of water, remove contaminated clothing and seek immediate medical attention.

WARNING: Observe all warning notes on the battery.

WARNING: If ingested; seek immediate medical attention. Do not induce vomiting or give fluids to drink.

WARNING: Batteries produce explosive gases. Keep sparks, flames and cigarettes away. Ventilate when charging or using in enclosed space. Always shield eyes when working near batteries.

Battery Replacement

It is recommended that the battery is replaced by an authorised Lotus Retailer, but if a battery replacement is not being carried out by an authorised Lotus Retailer then ensure to:

- Replace it with a battery with the same size, cold starting capacity and type as the original battery, refer to the 'Technical Data' section of this handbook for further information.
- Switch off all electrical loads and remove the keyfob from the vehicle cabin.

- Wait for at least 30 MINUTES after switching off the ignition to allow the engine management system to adjust the setting of some components ready for restarting.
- Disconnect the black negative - battery cable first and reconnect last.

Battery Disposal

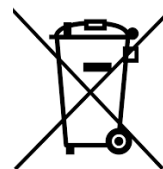

Vehicle batteries must not be disposed of with the normal household waste. They must only be disposed of at recycling centres or electrical specialists that are authorised to accept batteries for recycling.

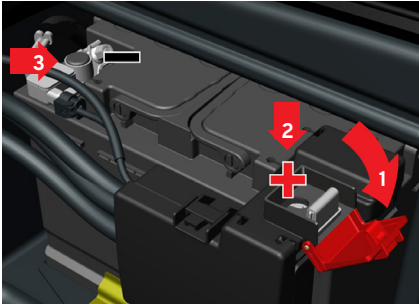

Battery Charging

With normal daily use, it should not be necessary to use a battery charger. In low usage conditions, it is important to maintain the battery charge state using a suitable trickle charger, or automatic battery management conditioner.

NOTE: A battery conditioner will maintain a fully charged battery but cannot recharge if the battery becomes discharged.

Starting difficulties may be experienced after an unused period of 18 days approximately.

A battery conditioner continuously monitors battery charge state and switches on and off automatically to maintain the battery in a fully charged condition.

To trickle charge the battery open the positive jump-starting point terminal cover (1) and connect the red positive + lead and black negative - lead terminals of the charger or automatic battery conditioner to the corresponding red + positive (2) and black negative - vehicle (3), battery terminals until 12.8 volts is achieved.

NOTE: Follow any instructions and safety warnings included with the trickle charger or battery conditioner.

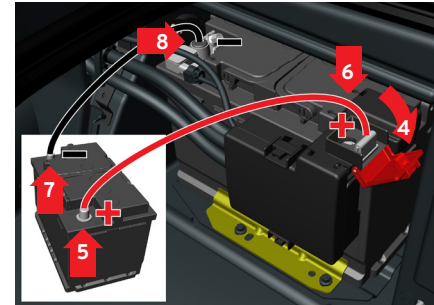

Jump Starting

In an emergency the vehicle with a discharged battery may be started from another vehicle with a 12V negative earth electrical system but be aware that such a process can cause damage to vulnerable electronic controllers, which would not be covered under the terms of the vehicle warranty.

When jump starting the vehicle, the following procedure is recommended to avoid short circuits or other damage:

1. Remove the battery access cover, see page 206.
2. Ensure that the vehicle's ignition system is in position 0.

VEHICLE CARE

3. Ensure the engine is switched off in the donor vehicle and make sure that the two vehicles do not touch each other.
4. Open the positive jump-starting point terminal cover.
5. Connect one clamp of the red jumper cable to the donor vehicle's battery's red positive + terminal post.
6. Connect the other clamp of the red jumper cable onto the Lotus vehicle's red positive + jump-starting point.
7. Connect one clamp of the black jumper to the donor battery's negative – terminal post.
8. Connect the other clamp of the black jumper cable onto the Lotus vehicle's negative -battery post (4).
9. Check that the jumper cable clamps are securely attached to avoid sparks during the starting attempt.
10. Start the engine of the donor car and allow it to run a few minutes at a fast idle speed.
11. Start the Lotus vehicle engine.
12. Remove the jumper cables in the reverse order of fitment, (black negative -, then red positive +).

13. Make sure that neither of the black negative - jumper cable clamps comes into contact with either the donor or Lotus vehicle's positive jump-starting point, donor vehicle's battery positive terminal or the clamp connected to the red jump lead.

Have the cause of the discharged battery investigated and rectified and trickle charge the battery as shown on page 207.

 **WARNING:** Ensure that tools or metal watches or jewellery do not contact the battery terminals or electrically live components.

 **WARNING:** It is most important that the correct procedure is followed to reduce the risk of damage to either vehicle's electrical system and most importantly, to minimise the danger of a spark induced battery explosion.

 **WARNING:** Check that the donor vehicle also has a 12V negative earth electrical system.

 **WARNING:** Use only jumper cables of adequate thickness, fitted with completely insulated clamps. The cables must be long enough to allow that neither vehicles nor cables touch each other.

 **WARNING:** Follow all warnings and instructions of the jumper cable manufacturer.

 **WARNING:** When connecting the jumper cables, keep them away from moving engine parts.

 **WARNING:** The two vehicles must not contact each other, or current could flow as soon as the positive terminals are connected.

Fuses

Contact your authorised Lotus Retailer if a fuse repeatedly fails.

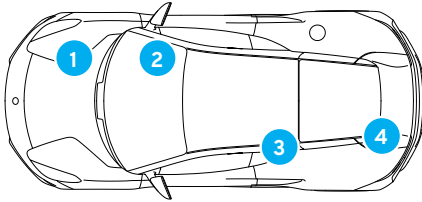
Fusebox Locations

- 1 Front fusebox.
- 2 Footwell fuseboxes.
- 3 Rear fusebox.
- 4 Battery fusebox.

Fuse Replacement

- Look in the fuse diagrams on the following pages to locate the fuse.
- Pull out the fuse and check if the fuse wire has broken.
- If the fuse has broken, replace it with a new fuse of the same colour and amperage rating.

⚠ WARNING: Replacing a fuse with one of a higher rating may cause a fire.

⚠ CAUTION: Replacing a fuse with one of a higher rating or a foreign object may cause damage to the vehicle's electrical systems.

📖 NOTE: If a fuse of the correct rating is not available, use one of a lower rating as a temporary measure.

📖 NOTE: Fuses may also be fitted that do not protect any circuit.

VEHICLE CARE

Front Fusebox

1. Open the front access panel, see page 185.
2. Remove the 5 fixings securing the front fusebox cover panel (located on the passenger side of the vehicle) and remove the panel.

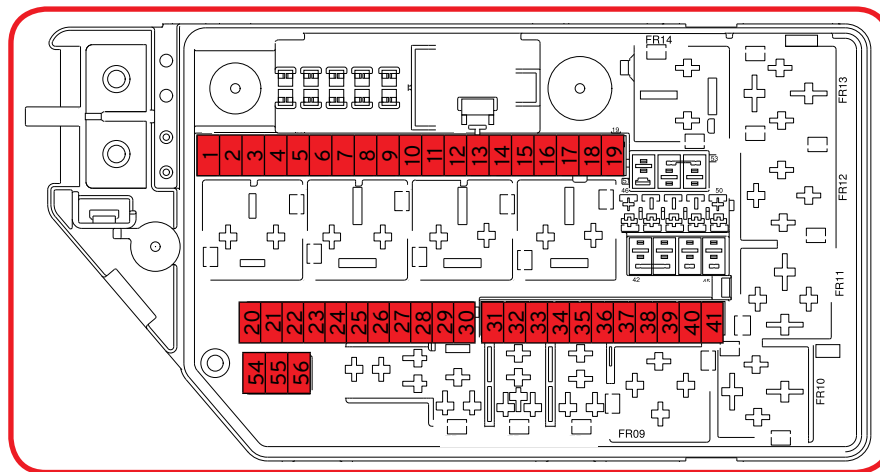

VEHICLE CARE

No.	Circuit	Rating	Type
1	Spare		Micro
2	Spare		Micro
3	Spare		Micro
4	Spare		Micro
5	Spare		Micro
6	Spare		Micro
7	Spare		Micro
8	Spare		Micro
9	Spare		Micro
10	Spare		Micro
11	Spare		Micro
12	Headlamp unit - right-hand	20	Micro
13	Headlamp unit - left-hand	20	Micro
14	Supplementary restraint system, occupancy weight sensor passenger, belt tension sensor front right	5	Micro
15	Exhaust actuator	5	Micro
16	Spare		Micro
17	Spare		Micro
18	Vehicle Dynamics Domain Master - VDDM (brake module)	5	Micro
19	Seat occupant weight sensor	5	Micro
20	Relay - coil supply	5	Micro
21	Battery backed-up sounder	5	Micro
22	Recirculation flap actuator, Temperature flap actuator left side	5	Micro
23	Spare		
24	Spare		

VEHICLE CARE

No.	Circuit	Rating	Type
25	Spare		Micro
26	Spare		Micro
27	Spare		Micro
28	Spare		Micro
29	Horn relay	20	Micro
30	Low temperature radiator fan relay	30	Micro
31	Spare		MCase
32	Control unit blower motor, Temp flap actuator left side, Recirculation flap actuator	40	MCase
33	Vehicle Dynamics Domain Master - VDDM (brake module)	40	MCase
34	Vehicle Dynamics Domain Master - VDDM (brake module)	40	MCase
35	Spare		MCase
36	Headlamp relay	30	MCase
37	Spare		MCase
38	Spare		MCase
39	Spare		MCase
40	Spare		MCase
41	Spare		MCase
42	Spare		MCase
43	Spare		MCase
44	Spare		MCase
45	Spare		Mcase
46	Spare		Micro
47	Spare		Micro
48	Spare		Micro

VEHICLE CARE

No.	Circuit	Rating	Type
49	Spare		Micro
50	Spare		Micro
51	Spare		MCase
52	Spare		MCase
53	Spare		MCase
54	Spare		Micro
55	Headlamp unit - left-hand	20	Micro
56	Headlamp unit - right-hand	20	Micro
M1	Fuse box supply	80	Midi
M2	Spare		Midi
M3	Fan control module	70	Midi
M4	Spare		Midi
M5	Spare		Midi

VEHICLE CARE

Footwell Fusebox

Located in the passenger footwell and is accessed by removing the toe board panel which is secured by a quarter turn fastener on each corner.



The toe board panel is an occupant crash protection component. Never drive the vehicle without the toe board panel being installed and fitted correctly.

⚠ WARNING: The toe board either not installed or incorrectly fitted could result in unbelted front passenger being at risk of injury to their upper leg area in the event of unbelted crash situation.

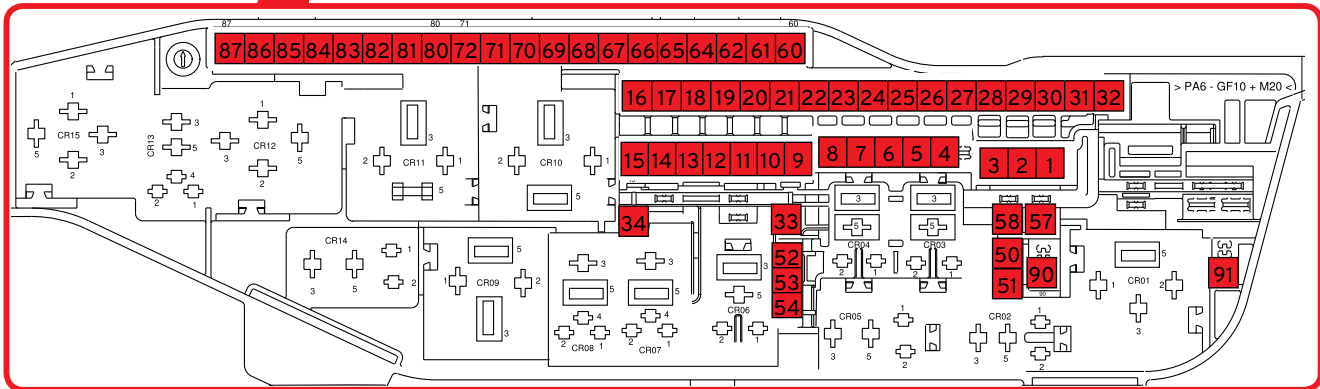

VEHICLE CARE

No.	Circuit	Rating	Type
1	Spare		Mcase
2	Spare		Mcase
3	Spare		Mcase
4	Spare		Mcase
5	Wiper motor module	30	Mcase
6	Spare		Mcase
7	Audio booster (premium specification)	25	Mcase
8	Audio module	25	Mcase
9	Seat module - left	20	Micro
10	Infotainment head unit	10	Micro
11	Door module - front left	20	Micro
12	Seat module - right	20	Micro
13	Door module - front right	20	Micro
14	Active safety domain master	5	Micro
15	Steering column lock	7.5	Micro
16	Diagnostic socket (ODB I)	10	Micro
17	Steering wheel module	5	Micro
18	Radio frequency antenna	5	Micro
19	Relay coil supply	5	Micro
20	Centre console switch module	5	Micro
21	Brake pedal sensor	5	Micro
22	Climate control module	7.5	Micro
23	Centre stack display	5	Micro
24	Interior motion sensor	5	Micro

VEHICLE CARE

No.	Circuit	Rating	Type
25	Telematics module	5	Micro
26	Driver information module	5	Micro
27	Start switch, gear selector module, parking brake switch	5	Micro
28	Electronic toll collect module	5	Micro
29	Ventilation flap actuator, defroster flap actuator	5	Micro
30	Silent alarm module	5	Micro
31	Spare	5	Micro
32	Spare		Micro
33	Spare		Micro
34	Engine Bay EFCM_2 Relay	10	Micro
40	Spare		MCase
41	Spare		MCase
42	Spare		MCase
50	Auxiliary water pump	5	Micro
51	Spare		Micro
52	Spare		Micro
53	Power outlet - passenger compartment	15	Micro
54	Charging port - rear view mirror, USB charging port - floor console right	10	Micro
55	Spare		MCase
56	Spare		MCase
57	Spare		MCase
58	Spare		MCase
60	Spare	0	Micro
61	Spare		Micro

VEHICLE CARE

No.	Circuit	Rating	Type
62	Spare		Micro
63	Electronic toll collection module	5	Micro
64	Spare		Micro
65	Supplementary restraint system	5	Micro
66	Front radar module, forward looking, camera heater	5	Micro
67	Spare		Micro
68	Spare		Micro
69	Spare		Micro
70	Spare		
71	Spare		
80	Sun sensor	5	Micro
81	USB connection	7.5	Micro
82	Rain/light sensor module, vanity mirror illumination, overhead console, glove box illumination, glove box switch, interior rear view mirror module	7.5	Micro
83	Side obstacle detection - left, side obstacle detection - right	5	Micro
84	Spare		Micro
85	Spare		Micro
86	Spare		Micro
87	Spare		Micro
90	Spare		Micro
91	Spare		Micro

VEHICLE CARE

Rear Fusebox

The rear fusebox is positioned behind the left-hand rear quarter trim panel.

Pull off the panel to access the rear fusebox.

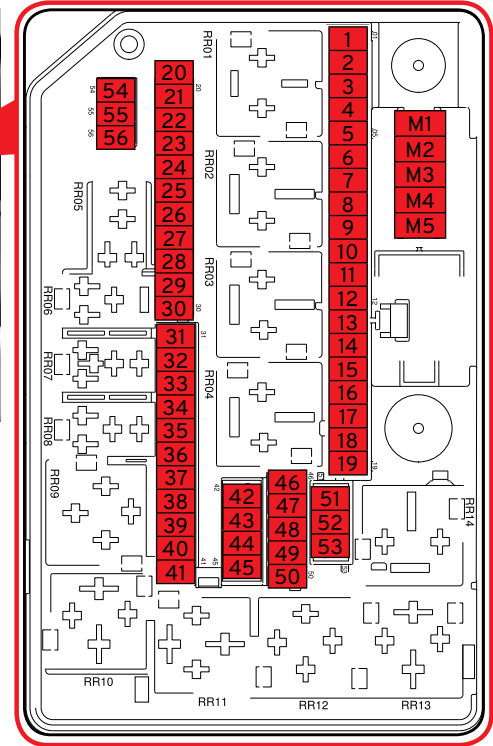

VEHICLE CARE

No.	Circuit	Rating	Type
1	Pump electronic module, powertrain control module	5	Micro
2	Engine control module, electronic gear selector module	5	Micro
3	Air conditioning compressor solenoid	5	Micro
4	Spare		Micro
5	Engine control module	10	Micro
6	Spark plug, ignition coil, capacitor filter - left, capacitor filter - right	10	Micro
7	Injector	7.5	Micro
8	Pump - water cooled charge air cooler	15	Micro
9	Solenoid variable valve timing VVT inlet and exhaust B, evap purge valve, Solenoid variable valve timing VVT inlet and outlet, canister close valve	7.5	Micro
10	Oxygen sensor 1 - left-hand front, oxygen sensor 3 - linear right-hand front, oxygen sensor 4 diagnostic right-hand rear, oxygen sensor rear	10	Micro
11	Relay coil supply	5	Micro
12	Engine control module	5	Micro
13	Electronic gear selection module	5	Micro
14	Alternator control module	5	Micro
15	Spare		Micro
16	Air conditioning compressor solenoid	7.5	Micro
17	Gear neutral selector	5	Micro
18	Spare		Micro
19	Spare		Micro
20	Relay coil supply	5	Micro
21	Alternator control module	5	Micro
22	Engine control module	5	Micro

VEHICLE CARE

No.	Circuit	Rating	Type
23	Spare		Micro
24	Spare		Micro
25	Spare		Micro
26	Air conditioning clutch relay	5	Micro
27	Spare		Micro
28	Oil cooler pump relay	15	Micro
29	Fuel pump relay	20	Micro
30	Spare		Micro
31	Spare		MCase
32	Central electronic module	40	MCase
33	Spare		MCase
34	Central electronic module	40	MCase
35	Spare		MCase
36	Spare		MCase
37	Spare		MCase
38	Spare		MCase
39	Window washer pump front relay	30	MCase
40	Spare		MCase
41	Rear defroster relay	25	MCase
42	Spare		MCase
43	Spare		MCase
44	Starter relay	30	MCase
45	Spare		MCase
46	Gear shift actuator	5	Micro

VEHICLE CARE

No.	Circuit	Rating	Type
47	Spare		Micro
48	Spare		Micro
49	Spare		Micro
50	Spare		Micro
51	Transmission control module	30	MCase
52	Spare		MCase
53	Spare		MCase
54	Spare		Micro
55	Spare		Micro
56	Spare		Micro
M1	Spare		Midi
M2	Spare		Midi
M3	Spare		Midi
M4	Spare		Midi
M5	Spare		Midi

VEHICLE CARE

Battery Fusebox

Removal of the mega fuses requires workshop tools. The negative battery terminal clamp must also be disconnected from the battery before these fuses are removed and inspected. Because of the high amperage rating of the mega fuses, Lotus recommends that inspection and removal of these fuses is only performed by your Lotus Retailer.

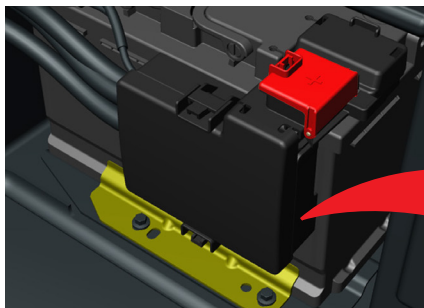

⚠ WARNING: If a mega fuse terminal is inadvertently earthed (e.g., when using a spanner) whilst the battery negative terminal is still connected, the resultant short circuit, with heavy sparking and current flow, could cause serious burns and/or a fire.

⚠ WARNING: Ensure that tools or metal watches or jewellery do not contact the battery terminals or electrically live components.

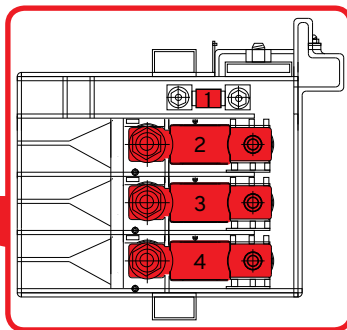

No.	Circuit	Rating	Type
1	Battery monitoring sensor	15	Micro
2	Starter motor	400	Mega
3	Rear junction box	200	Mega
4	Front junction box	250	Mega

Exterior Lamps

All lamps are illuminated by light emitting diodes (LED's) and are serviceable only by replacement of the complete units.

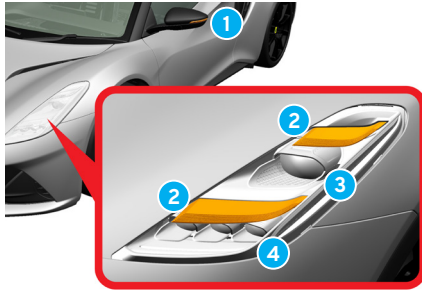

Front Lamps

- 1 Side repeater.
- 2 Position/daytime running/turn indicator.
- 3 Dip beam.
- 4 Main beam.

NOTE: Fan motors are fitted to the front lamps to aid thermal management and may be audible when the engine is started.

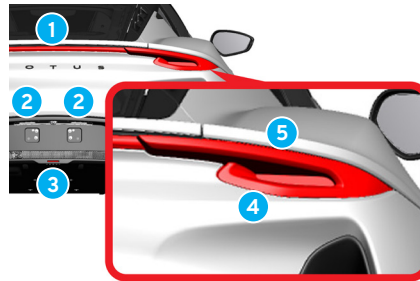

Rear Lamps

- 1 Centre high mounted stop lamp.
- 2 Licence plate.
- 3 Reverse/rear fog*.
- 4 Position/brake**.
- 5 Position/turn indicator**.

* If fitted.

**Will also illuminate when daytime running lights are activated.

NOTE: All lamps may temporarily condensate on the inside of the lens. This is normal and will slowly dissipate once the lamps have been switched on.

Vehicle Recovery

To aid vehicle recovery, such as winching onto a flatbed car transporter, screw the recovery eye supplied in the vehicle tool kit into the threaded mounting point located behind the left-hand side of the front bumper centre grille.

WARNING: Use only towing equipment designed specifically for this purpose.

CAUTION: Only in an emergency should the car be towed using the recovery eye and then only for the shortest distance necessary.

CAUTION: The vehicle may be damaged if winched using the towing eye if the vehicle ground clearance is too low.

VEHICLE CARE

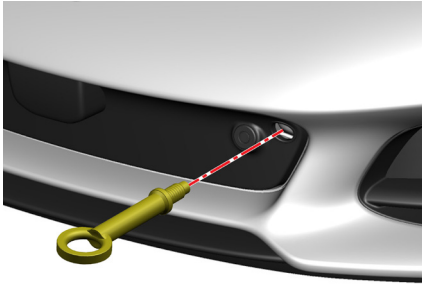

Using the Recovery Eye

- Remove the protective bung and screw the recovery eye fully counter-clockwise into the mounting point.

NOTE: Ensure the recovery eye is screwed firmly into the mounting point as possible before winching the vehicle.

- Put the vehicle into ignition mode II (active) and release the electric parking brake, see pages 149 and 162.
- For manual transmission vehicles, put the gear lever into neutral.

- For automatic transmission vehicles, select N - Neutral, see page 155
- Ensure that the keyfob is left in the cabin when the vehicle is being towed.

NOTE: Towing dollies must be placed under the rear wheels before winching the vehicle if neutral cannot be selected or the parking brake released.

CAUTION: Attempting to winch the vehicle with the vehicle still in gear or the parking brake still applied will cause damage to the transmission or braking systems.

CAUTION: Attaching winching/towing equipment to the vehicle body or suspension will result in damage to the vehicle.

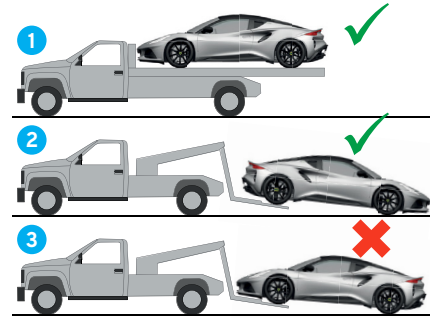

Transporter Recovery

Lotus recommend recovery is carried out by your Lotus Retailer or a professional vehicle recovery service using a suitable flatbed transporter or trailer.

- 1 ✓ Recommended method.
- 2 ✓ Alternative method with the front wheels (non-driving wheels), rotating on the ground.
- 3 ✗ Never tow a vehicle with the rear driving wheels rotating on the ground, as this may cause serious damage to the transmission.



Vehicle Tie-Down

When moving a vehicle by transporter or trailer, the vehicle should be secured only by chocking and strapping around the road wheels.

- ⚠ **CAUTION:** Attaching restraints around suspension linkages, recovery eye or chassis or body components may cause damage.

Vehicle Towing

Only in an emergency should the vehicle be towed using the recovery eye and then only for the shortest distance necessary.

Before towing ensure to deactivate the power steering lock and release the electrical parking brake, see pages 149 and 162.

- ⚠ **WARNING:** Use only towing equipment designed specifically for this purpose.
- ⚠ **CAUTION:** Using incorrect towing equipment may cause damage to your vehicle.

Towing Automatic Models

Never tow a vehicle with an automatic transmission for a long period of time as this may cause serious damage to the transmission.

Towing a Trailer

This vehicle is not equipped with either a rear towing mount or any chassis mounting points to attach a tow bar assembly, therefore is not suitable for towing a trailer.

Exterior Cleaning

Regular inspection of the vehicle paint finish and frequent washing are the best preventions against paint deterioration caused by contaminants such as:

- Dust, soot, ash and acidic or alkaline aerosol.
- Tree sap and insect fluids.
- Bird droppings which can chemically etch the paint.
- Leaves which contain chemicals which can stain light finishes.
- Blowing sand and dust which can cause abrasion damage.

- 📖 **NOTE:** To prevent damage to the paint, immediately remove contaminants as described above as soon as you see them. Do not wait until the vehicle is due for a complete wash.

VEHICLE CARE

Handwashing

Lotus recommends that your vehicle is only washed by hand.

 **CAUTION:** Automatic car washers and jet washers may damage the paint finish. Damage caused by using them will not be covered under the terms of the vehicle warranty.

- Rinse the entire car until any dirt has been removed, this will reduce the risk of scratching the paintwork whilst washing. Ensure not to spray water directly into any air intake/ventilation grilles or locks.
- Thoroughly wash using plenty of lukewarm water and a proprietary car shampoo, never use household detergent or washing up liquid.

 **NOTE:** The car shampoo must be non-abrasive, without strong solvents, and have a pH value between 3 and 11 (neither strongly acidic nor strongly alkaline).

- Wash in the shade and use a cotton chenille wash mitt or a sponge rinsed frequently to minimise the retention of dirt particles.

- Use a straight back and forth washing motion to avoid swirled micro scratches and rinse the body thoroughly.
- Dry the paintwork after washing using a suitable microfibre towel or chamois leather.

Under Vehicle Cleaning

To minimise degradation from road salt, the underside of the chassis should be rinsed with clean water on a regular basis. Many fuel filling stations offer pressure washing facilities ideal for this purpose, but do not use on the bodywork, headlights or around protective gaiters used on suspension, brake or powertrain components.

Tar Spots

If necessary, use white spirit to remove tar spots and stubborn grease stains (but do not apply to the windscreen wiper blades or rubber trims), then immediately wash the area with water and car shampoo.

Windscreen Cleaning

Use a proprietary glass cleaning product on the windscreen and other windows. Clean the wiper blade with windscreen wash solvent to prevent juddering and smearing.

Alloy Road Wheels

It is recommended that the alloy road wheels are washed with the same car shampoo as is used to wash the bodywork. Use a brush having only nylon bristles. During the winter months, particularly when salt has been used on the roads for the dispersal of snow and ice, wash thoroughly to remove accumulated road filth from the wheels and tires.

 **CAUTION:** The chemicals in road wheel cleaning solutions can damage the surface finish of the wheel rims.

Exterior Lighting

Headlamps and all other light units should only be washed with lukewarm water and a proprietary car shampoo, using a clean non scratching sponge, never use household detergent or washing up liquid.



NOTE: After washing, the headlamps and rear lamps may temporarily have condensation on the inside of the lens. This is normal and will slowly dissipate once the lamps have been switched on.

Park Assist System Sensors

As recommended for the vehicle body, only handwash the sensors.

Park Assist Camera Lens

As recommended for the vehicle body, only handwash the camera.



CAUTION: Automatic car washers and jet washers may damage the sensors and camera lens.

See page 226 for further information.

Paintwork Polishing

After normal washing and drying, the application of a good quality liquid polish will restore the original paint lustre. Higher gloss of the paint finish and added protection against contamination can be obtained by the use of a wax polish. However, this can only be used successfully on a clean surface, from which the previous application has been removed.

Do not apply wax or polish on plastic and rubber trims. If it is necessary to use a degreasant on plastic and rubber, only rub with light pressure using a soft sponge.

Polishing trim mouldings could damage the surface layer.

Polishers that contain abrasives must not be used.

Interior Cleaning

Centre Display

It is recommended to clean the centre display screen regularly to maintain its performance and readability.

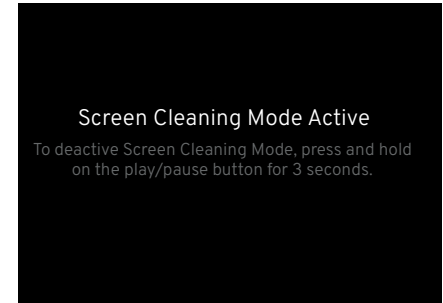



Screen Cleaning Mode

- Press and hold the play/pause button in the centre console for 2 seconds.
- An overlay screen will be displayed on the centre screen.
- Follow the on-screen instructions.
- Using small circular movements, clean the screen using microfibre cloth.
- Press and hold the play/pause button for 2 seconds again to return to the screen home display.

VEHICLE CARE

 **NOTE:** If required, lightly moisten the microfibre cloth with clean water.

 **CAUTION:** Do not spray any interior car cleaners including windscreen or glass cleaner (or any other chemicals) directly on the centre display.

 **CAUTION:** The microfibre cloth must be clean and free from dust or dirt. Never use abrasive cloths or paper towels which could scratch the display screen.

 **CAUTION:** Use light finger pressure only when cleaning the display screen, heavy pressure may damage the screen.

Cloth Trim

Normal cleaning consists of occasionally wiping lightly with a cloth dampened in a mild soap and water solution; it is important that the cloth is only dampened, not soaked. Alternatively, a proprietary upholstery cleaner may be used.

Leather & Vinyl Trim

This should be wiped over occasionally with a cloth dampened in warm soapy water. Use a mild, non-caustic toilet soap or soap flakes. Repeat the operation using a fresh cloth and water only but avoid soaking the leather. Finish by drying and polishing with a soft dry cloth.

The manufacturers of the leather do not recommend the use of any hide 'food' and prohibit the use of petrol or detergents, furniture creams and polishes.

Lotus use premium quality leather, specifically tanned and dyed for automotive use. As a natural material, leather ages in various ways and may, over time, exhibit signs of cracking, scuffing, shrinking, etc. Such wear is not an indication of a defect, but rather the natural maturing of the leather.

Alcantara® Trim

It is recommended that it is cleaned regularly of any loose debris, dust etc., but only by using a soft brush, a dry cloth or a vacuum cleaner. Then a slightly moistened white cotton cloth

should then be wiped over the material. Do not use any cloths or paper containing print as this may release their ink into the material.

Stain Removal: Alcantara® have compiled the recommended cleaning products and best methods of stain removal for their materials. This information is available to view on their website:

alcantara.com

Lotus Cars recommends that you view and follow the information provided on this website prior to attempting any stain removal on your Evora Alcantara® trim.

Seat Belt Cleaning

The seat belts may be sponged with warm water and should be allowed to air dry naturally before use. Do not use chemical cleaners and never attempt to bleach or dye the webbing.

Take care to avoid the ingress of foreign bodies into the buckle mechanism that could affect the functionality of the latch. There is no provision for disassembly.

The seat belt should be replaced if the webbing becomes frayed, contaminated or damaged. Not checking or maintaining seat belts can result in them not working properly when needed. Check all the belts regularly and have any problem corrected immediately.

Footwell Cleaning

Use only correctly secured Lotus approved carpet mats in the footwells. Floor coverings made from plastic or other non-breathable materials may trap moisture and initiate surface corrosion of the footwell floors.

Sill Trims

Note that the sill trim covers will be subjected to wear and tear during the normal course of cabin access and may require periodic replacement dependent on the level of use and the owner's preference.

Door Lock

It is recommended to periodically operate the left-hand exterior door key lock in order to check and maintain its functionality, should this ever be required. A special lock spray grease will maintain smooth and reliable

operation. Be aware that any use of silicone based general maintenance sprays can wash out the grease required for mechanism longevity. Your Lotus Retailer will be pleased to advise.

VEHICLE CARE

Severe Service Conditions

Certain operating conditions can cause rapid degradation of the engine and transmission oil quality. If any of the 'severe service' conditions described below apply, it is recommended that the engine and transmission oil and filters are changed more frequently than listed in the maintenance schedule.

- Driving in dusty areas (e.g., on non-tarmacked roads); Change the oil and filter as soon as possible after driving in a dust storm.
- Stop/start driving with frequent short trips where the engine rarely warms up thoroughly (especially in cold weather/climates); and/or frequent or prolonged idling.
- Track use, with repeated high rpm, wide throttle openings and high oil temperatures. For appropriate maintenance, discuss with your Lotus Retailer.

The use of the car off road or in a competitive manner, including timed runs or laps, will invalidate the warranty and require appropriate levels of expert car preparation and servicing. Refer to

the separate Warranty Booklet section 2 'Intended Purpose'. Please be aware that the use of products with specifications other than those shown on the next page could cause damage to the engine and transmission that would not be covered under the terms of the Lotus vehicle warranty.

For fluid quantities please see 'Capacities' on page 233 For change intervals please refer to the Maintenance Schedule contained within the separate Maintenance Record booklet.

The approved lubricants have been developed and tested in order to guarantee your vehicle's reliability and optimal performance through time, based on the required scheduled maintenance recommended by Lotus.

Recommended Lubricants

Using the specified lubricants is vital. Lower quality oils may not provide adequate protection before the next scheduled service and may also result in high oil consumption.

Throughout the life of the vehicle a fully synthetic 0W/40 oil must be used, see 'Recommended Fluids and Lubricants' on page 232 for further details.



NOTE: Lotus recommends against the use of any oil additives, the use of which may invalidate the terms of the New Vehicle Warranty.

TECHNICAL DATA

TECHNICAL DATA

Recommended Fluids and Lubricants

Engine

Approved Product: Total Quartz 9000 Energy
Viscosity / Quality Standard: SAE 0W/40 / API SN: ACEA A3/B4

Manual Transmission

Approved Product / Quality Standard: Texaco Delo Syn-AMT XV 75W-80 (fully-synthetic) / API GL-4
Approved Product / Quality Standard: Havoline Multigear MTF HD 75W-80 (fully-synthetic) / API GL-4

Automatic Transmission

Approved Product: Toyota Genuine ATF WS Transmission oil
Approved Product: Exxon Mobil JWS 3324 Transmission oil

Brake & Clutch System

Approved Product / Specification: Petronas Tutela Top 4/S brake fluid / DOT 4

Engine and Charger Coolant Additive

Approved Product: Total Glacelf SI-OAT
Type / Colour: Monoethylene glycol with OAT corrosion inhibitors / Pink

Power Steering System (PAS)

Approved Product / Specification: Fuchs Titan ATF 3000 Dexron II (D)

Windscreen Washer Bottle

Approved Product: Petronas Tutela SC35 windscreen washer fluid

TECHNICAL DATA

Capacities

Engine Oil* 6.0 litres

High/Low Dipstick Mark Difference 1.5 litres

Windscreen Washer Bottle 2.5 litres

Fuel Tank 58 litres

Luggage Compartment Stowage 151 litres

*Figure shown is for the engine and oil filter capacity, additional oil is contained within the oil cooler circuit which cannot be drained during a routine oil change.

WLTP Figures

Fuel Consumption

Low 17.1 l/100km

Medium 11.4 l/100km

High 9.7 l/100km

Extra 10.5 l/100km

Combined 11.3 l/100km

CO₂ Emissions

Low 391 g/km

Medium 259 g/km

High 221 g/km

Extra 240 g/km

Combined 258 g/km

Figures applicable to both manual and automatic transmission models

Unleaded Fuel Requirement

Minimum 95 RON - (E10)

Recommended 97 RON - (E5)

Engine Data

Power Output 298kW @ 6,800 rpm

Idle Speed 750 ±200 rpm

Maximum Continuous Engine Speed 6,550 rpm*

Maximum Momentary Engine Speed 6,800 rpm

*In sports mode in 4th, 5th or 6th gears but may vary dependent on engine conditions.

TECHNICAL DATA

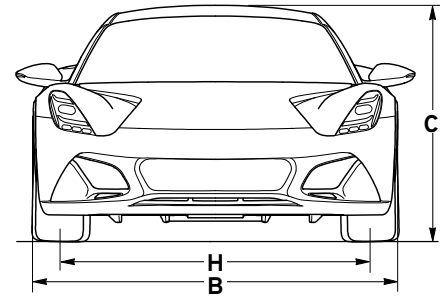
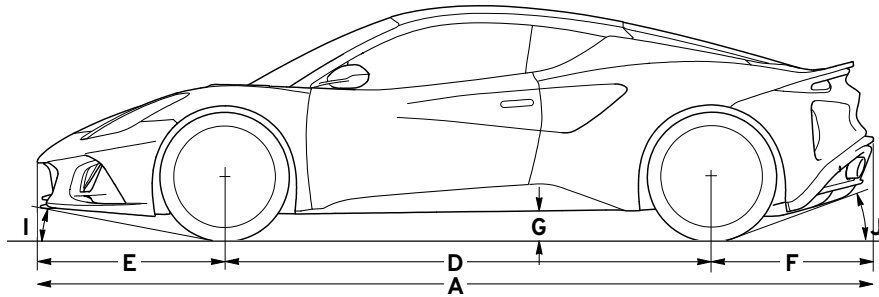

Dimensions

A Overall length	4413 mm
B Overall width	1896 mm
C Overall height*	1235 mm
D Wheelbase	2570 mm
E Front overhang	988 mm
F Rear overhang	855 mm
G Ground clearance*	140 mm
H Track front	1624 mm
H Track rear	1610 mm
I Approach angle front	8.7°
J Approach angle rear	17.9°

* Mid-laden weight.

Weights

Manual Transmission	
Unladen:	
Total	1493 kg
Front	572 kg
Rear	921 kg

Gross (maximum) vehicle weights

Total	1763 kg
Front	690 kg
Rear	1073 kg

Maximum permissible (GVW) 2 x 100kg + 50kg luggage + 20kg luggage behind seats.

Weights

Automatic Transmission	
Unladen:	
Total	1500 kg
Front	572.5 kg
Rear	927.5 kg

Gross (maximum) vehicle weights

Total	1770 kg
Front	682.5 kg
Rear	1087.5 kg

Maximum permissible (GVW) 2 x 100kg + 50kg luggage + 20kg luggage behind seats.

Tyres

Road Tyres	Position	Size Load/Speed Rating	Sidewall Designation Marking
Michelin Pilot Sport Cup 2	Front	245/35 ZR20 - 95Y XL	LTS
	Rear	295/30 ZR20 - 101Y XL	LTS
Goodyear Eagle F1 Supersport	Front	245/35 ZR20 - 95Y XL	LTS
	Rear	295/30 ZR20 - 101Y XL	LTS

Recommended Inflation Pressures	Position	Standard Inflation Pressure	High Speed Pressures*
	Front	2.0 bar (29 lb/in ²)	2.2 bar (32 lb/in ²)
	Rear	2.2 bar (32 lb/in ²)	2.4 bar (35 lb/in ²)

Winter Tyres	Position		Sidewall Designation Marking
Michelin Pilot Alpin	Front	235/35 ZR20 - 92W XL [†]	None - Standard Michelin
	Rear	285/30 ZR20 - 99W XL [†]	None - Standard Michelin

Recommended Inflation Pressures	Position	Cold Inflation Pressure
	Front	2.6 bar (37 lb/in ²)
	Rear	2.5 bar (36 lb/in ²)

Snow Chains	Position
Konig CG - 9 105	Rear

* High speed pressures for road speeds in excess of 270 km/h.

† Winter tyres rated for road speeds of up to 270 km/h.

Failure to monitor and adjust the tyre pressures as necessary will result in premature and excessive tyre wear.

TECHNICAL DATA

Battery

Type	Platinum AGM096E
Voltage (V)	12
CCA (EN)	760
Ah Capacity (C20)	70
Size, L×B×H	278 x 175 x 190 mm

Declarations of Conformity

Shown on the following pages are the radio equipment output power table by frequency and certification approval for applicable markets.

Mexico	“La operación de este equipo está sujeta a las siguientes dos condiciones: (1) es posible que este equipo o dispositivo no cause interferencia perjudicial y (2) este equipo o dispositivo debe aceptar cualquier interferencia, incluyendo la que pueda causar su operación no deseada.”
--------	---

INDEX

A		B			
Accessories and Modifications.....	180	Battery.....	180, 206, 236	Driver Profiles.....	104
Active Electrical Module Cooling.....	142	Battery Charging.....	207	Keyboard.....	100
Adjusting Tyre Pressures.....	196	Battery Replacement.....	206	Notification Centre.....	94
Airbag Safety System.....	32	Jump Starting.....	207	Quick Panel.....	97
Airbag Warning Lamp.....	33	Battery Charging.....	207	System Settings.....	99
Inflatable Curtains.....	37	Battery Replacement.....	206	Widgets.....	103
Passenger Airbag Switch.....	35	Bodywork.....	180	Changing Drive Mode.....	165
Seat Belt Pretensioners.....	33	Brake/Clutch Fluid Level Check.....	193	Charge Cooler Expansion Tank.....	192
Side Airbags.....	36	Brake & Clutch System.....	232	Child Restraints.....	30
Air Conditioning.....	137, 180	Brake Lights.....	114	Suitable Child Seats.....	30, 32
Air Distribution.....	138	Brake Pads.....	159	Child Seat Installation.....	31
Air Recirculation.....	140	Brake Pedal.....	159	Cleaning.....	225
Air Temperature.....	138	Brakes.....	169	Alcantara Trim.....	228
Air Vents.....	141	Braking System.....	159	Alloy Road Wheels.....	226
Alarm.....	52	Anti-Lock Braking System.....	160	Cloth Trim.....	228
Alarm/Locking Preset Options.....	55	Brake Pads.....	159	Door Lock.....	229
Arming the Alarm.....	53	Brake Pedal.....	159	Exterior Cleaning.....	225
Disarming the Alarm.....	53	Electric Parking Brake.....	162	Exterior Lighting.....	226
Immobiliser.....	52	Footbrake.....	159	Handwashing.....	226
Lock and Alarm Indicator.....	52	Hill Start Assist.....	164	Interior Cleaning.....	227
Reduced Alarm Level.....	54	Hydraulic Brake Assist.....	160	Leather & Vinyl Trim.....	228
Switching off a Triggered Alarm.....	54			Park Assist Camera Lens.....	227
Alcantara® Trim.....	228			Park Assist System Sensors.....	227
Alcantara Trim.....	228	C		Screen Cleaning Mode.....	227
Alloy Road Wheels.....	226	Capacities.....	233	Seat Belt Cleaning.....	228
Ambient Lighting.....	116	Car Covers.....	181	Under Vehicle Cleaning.....	226
Anti-Lock Braking System.....	160	Centre Console.....	127	Windscreen Cleaning.....	226
App Launcher.....	98	Centre Display Overview.....	91	Climate Control System.....	135
Approach Lighting.....	114	App Launcher.....	98	Active Electrical Module Cooling.....	142
Auto Climate.....	140	Automatic Activation/Deactivation.....	93	Air Conditioning.....	137
Automatic Climate Temperature.....	141	Manual Deactivation.....	93	Air Distribution.....	138
Automatic Transmission.....	232	Device Projection.....	93	Air Recirculation.....	140
		Display Navigation.....	91	Air Temperature.....	138
		Display Operation.....	92	Air Vents.....	141
				Auto Climate.....	140

INDEX

Automatic Climate Temperature.....	141	Door Switches.....	44	E	
Centre Display	143	Drive-Away Locking	44	Electric Parking Brake.....	162
Climate Control Switches	137	Opening a Door from the Outside	43	Electronic Stability Control.....	161
Climate Fan.....	141	Drive-Away Locking.....	44	Electronic Steering Column Lock ..	135, 149
Demister	139	Drive Mode Display	67	Emergency Brake Lights	114
Heated Rear Screen/Door Mirrors	139	Drive Modes	164	Emergency Key Blade	50
Interior Air Cleaning System	142	Changing Drive Mode	165	Emira App	11
Clock	63	ESC 'Off'	165	Engine.....	232
Cloth Trim	228	Sport Mode.....	164	Engine and Charger Coolant Additive ..	232
Clutch Pedal	152	Tour Mode.....	164	Engine Compartment.....	186
Cold Engine Speed.....	65	Track Mode	164	Engine Compartment Panels.....	187
Copyright Information.....	15	Driver Display.....	57	Engine Coolant.....	191
Courtesy Lighting	116	Clock.....	63	Engine Coolant Temperature Gauge.....	63
Crash Event Data.....	15	Drive Mode Display.....	67	Engine Data.....	233
Cruise Control	81	Engine Coolant Temperature Gauge	63	Engine Data Recording	15
Cup Holders	127	Fuel Gauge.....	62	Engine Oil Level Check	188
D		Gear Display.....	67	ESC 'Off'	165
Daily Checks	184	Gear Shift Indicator	67	Exterior Cleaning.....	225
Daytime Running Lights.....	111	Indicator Symbols		Exterior Lamps	223
Declaration of Conformity for Radio		System Status Indicator Symbols		Front Lamps	223
Equipment.....	237	Warning Symbol Illumination.....	60	Rear Lamps	223
Demister	139	Indicator Symbols	58	Exterior Lighting	226
Device Projection.....	93	System Status Indicator Symbols	59		
Direction Indicators.....	112	Outside Air Temperature	64	F	
Door Lock	229	Performance Gear Shift Lighting.....	65	Footbrake.....	159
Door Mirrors.....	122	Speedometer.....	64	Front Access Panel.....	185
Adjusting the Door Mirror Glasses	123	Tachometer	64	Front Lamps.....	223
Automatic Angling During Parking	124	Tour Mode.....	57	Fuel Consumption (WLTP).....	233
Automatic Folding When Locking.....	123	Track Mode.....	58	Fuel Filler Flap	171
Folding the Door Mirrors.....	123	Sport Mode.....	57	Fuel Filling.....	171
Manual Angling During Parking	124	Trip Computer	72	Fuel Filler Flap.....	171
Door Pockets	128	Widget Options.....	71	Fuel Requirement.....	172
Doors		Driver Profiles	104	Using a Fuel Can.....	172
				Fuel Gauge	62

Fuel Requirement	172	Interior Trim	180	High/Low Beam Headlights.....	112
Fuse Replacement.....	209			Interior Lighting.....	116
Fuses	209	J		Ambient Lighting.....	116
Fuse Replacement	209	Jump Starting.....	207	Brightness Adjustment.....	117
				Courtesy Lighting.....	116
G				Ground Lighting	117
Gear Display	67	K		Luggage Compartment Lighting.....	116
General Safety	182	Keyboard	100	Overhead Console Switches	116
Glovebox.....	127	Keyfob Battery.....	48	Vanity Mirror Lighting	116
Glovebox Lighting.....	116	Keys.....	40	Interior Lights	
Ground Lighting	117	Automatic Locking.....	43	Glovebox Lighting	116
		Automatic Relocking.....	43	Light Switch.....	111
		Emergency Key Blade	50	Low Beam Lights	111
		External Locking/Unlocking Confirmation .	41	Position Lights.....	111
			41	Rear Fog Light.....	112
H		Keyfob Battery	48	Reverse Light.....	114
Handbook Information.....	11	Keyfob Range	41	Trip A Reset	113
Downloadable information Maps	11	Locking	42	Light Switch.....	111
Emira App.....	11	Unlocking	41, 43, 44, 50, 185	Lotus E-Call.....	177
Lotus Cars Website	11	Tailgate Opening Using Keyfob.....	45	Lotus Launch Control	68
Handwashing.....	226	Unlocking Options	41	Low Beam Lights.....	111
Hazard Warning Lights.....	113	Kick-Down	155	Luggage Compartment Lighting.....	116
Heated Rear Screen/Door Mirrors.....	139			Luggage Nets.....	128
High/Low Beam Headlights	112	L			
Hill Start Assist.....	164	Leather & Vinyl Trim	228	M	
HomeLink	174	Lighting.....	111	Manual Lap Timer	74
Home Safety Lights.....	115	Approach Lighting	114	Manual Transmission	232
Horn.....	134	Home Safety Lights.....	115	Media.....	78
Hydraulic Brake Assist.....	160	AUTO	111		
		Brake Lights	114	N	
I		Emergency Brake Lights.....	114	Notification Centre	94
Ignition Modes	149	Daytime Running Lights	111		
Inflatable Curtains.....	37	Direction Indicators	112		
Interior Air Cleaning System.....	142	Hazard Warning Lights	113		
Interior Cleaning	227				
Interior Lighting	116				

INDEX

O		Q		Seat Belt Pretensioners 33	
Outside Air Temperature.....	64	Quick Panel.....	97	Seatbelts.....	27
Overhead Console Switches.....	116	R		Child Restraints.....	30
Owner Maintenance.....	182	Raising the Vehicle.....	205	Door/Seat Belt Reminder.....	29
Brake/Clutch Fluid Level Check.....	193	Rear Fog Light.....	112	Fitting.....	27
Charge Cooler Expansion Tank.....	192	Rear Lamps.....	223	Fitting During Pregnancy.....	28
Daily Checks.....	184	Rearview Mirror.....	124	Seat/Door Mirror Memory Switches.....	133
Engine Compartment.....	186	Manual Dimming.....	124	Seats.....	132
Engine Compartment Panels.....	187	Automatic Dimming Mirror.....	125	Power Seats.....	132
Engine Coolant.....	191	Recommended Fluids and Lubricants		Seat/Door Mirror Memory Switches.....	133
Engine Oil Level Check.....	188	Automatic Transmission.....	232	Seat Fold.....	134
General Safety.....	182	Brake & Clutch System.....	232	Service Reminder.....	183
Service Reminder.....	183	Engine.....	232	Severe Service Conditions.....	229
Steering Fluid Reservoir.....	192	Engine and Charger Coolant Additive.....	232	Side Airbags.....	36
Track Use.....	182	Manual Transmission.....	232	Snow Chains.....	197, 235
Weekly Checks.....	184	Power Steering System (PAS).....	232	Software Updates.....	15
Windscreen Washer Reservoir.....	189	Windscreen Washer Bottle.....	232	Speed Limiter.....	83
Wiper Blade Renewal.....	190	Recommended Tyre Pressures.....	195	Speedometer.....	64
P		Recovery Eye.....	224	Sport Mode.....	161, 164
Park Assist Camera Lens.....	227	Resetting Trip Computer.....	76	Sport & Track Modes.....	158
Park Assist System.....	86	Reverse Light.....	114	Starting the Engine.....	150
Park Assist System Sensors.....	227	Road Tyres.....	235	Emergency Starting.....	150
Parking Assist Camera.....	88	Running-In.....	169	Switching off the Engine.....	151
Passenger Airbag Switch.....	35	Brakes.....	169	Steering Fluid Reservoir.....	192
Performance.....	73	Engine.....	169	Steering Wheel Adjustment.....	134
Performance Gear Shift Lighting.....	65	Stopping the Engine.....	169	Stopping the Engine.....	169
Phone.....	79	Tyres.....	169	Storage.....	127
Position Lights.....	111	S		Centre Console.....	127
Power Sockets.....	129	Safety Information.....	14	Cup Holders.....	127
12 Volt Power Socket.....	129	Before Driving Your Vehicle.....	14	Door Pockets.....	128
USB Ports.....	129	Screen Cleaning Mode.....	227	Glovebox.....	127
Power Steering System (PAS).....	232	Seat Belt Cleaning.....	228	Luggage Nets.....	128
				Sun Visors.....	125

INDEX

Wipers 119

The information included in this publication for applicable South American Countries was correct at the time of printing as shown below. Lotus has a policy of continuous product improvement and reserves the right to discontinue or change specification, design or equipment at any time without notice and without incurring any obligation whatsoever relative to the shown in this publication. You should keep in regular contact with your Lotus dealer to ensure that you are kept informed of any technical developments which may improve the specification, performance or safety of your vehicle.